

The Journal of The Royal Astronomical Society of Canada

# Journal

Le Journal de la Société royale d'astronomie du Canada

PROMOTING  
ASTRONOMY  
IN CANADA

October/octobre 2014  
Volume/volume 108  
Number/numéro 5 [768]

**Inside this issue:**

**Genealogy of Canadian  
Astronomers**

August Crossword Answers

Avoiding Battery Brownout

Stellar Sizes and Distances

Trying for the Tetrad

*Polaris and Its Net of Hydrogen*

## The Best of Monochrome.

Drawings, images in black and white, or narrow-band photography.

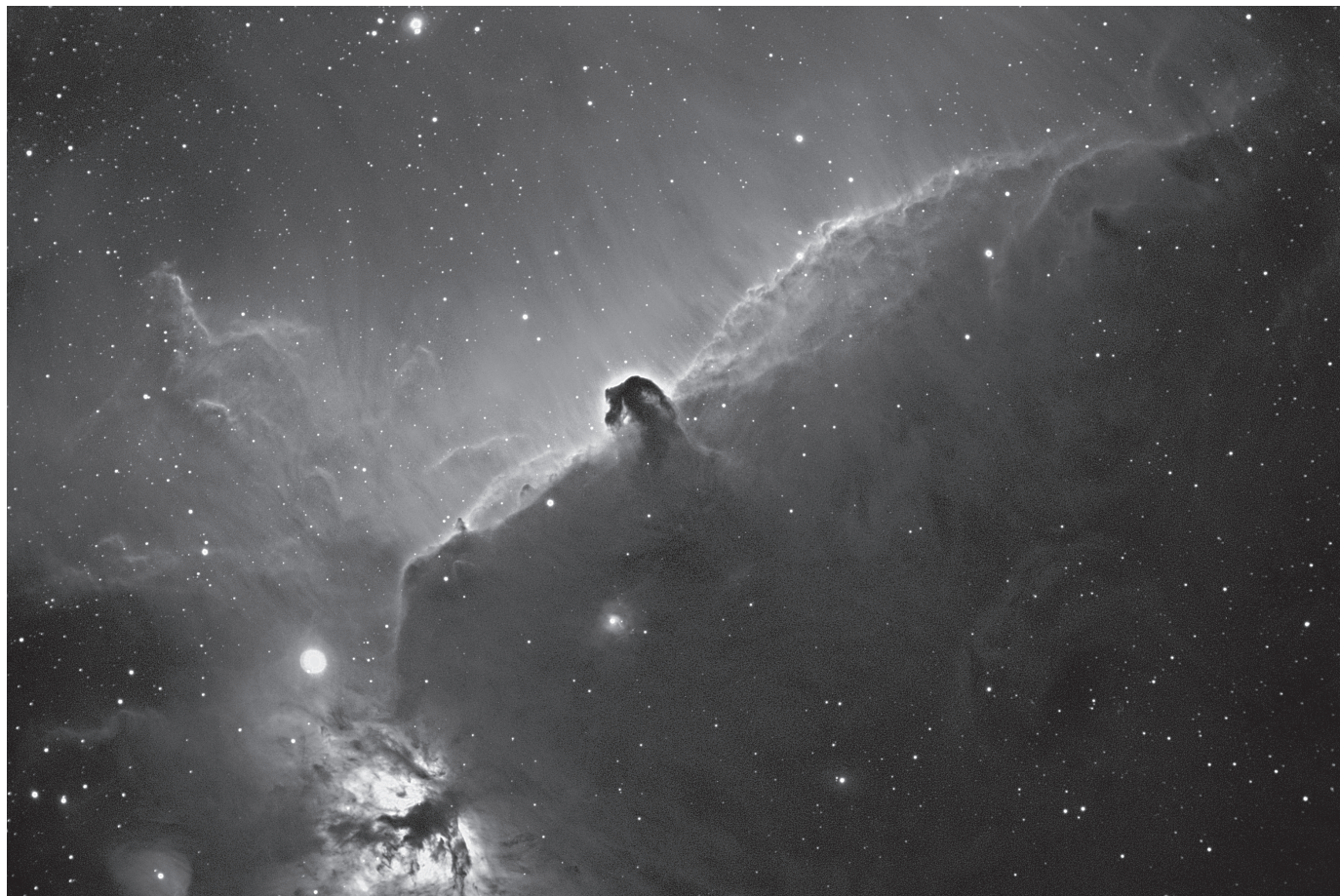

*The Horsehead Nebula (Barnard 33), silhouetted by the emission nebula IC 434, is part of the Orion Molecular Complex, which also includes another emission nebula, the Flame Nebula (NGC 2024), visible in the lower left. This 3-hour exposure was taken by Joel G. Parkes from his observatory in Meaford, Ontario, using a 5-nm H $\alpha$  filter in combination with an SBIG ST-L 11000 CCD camera and a Takahashi 130-mm refractor at f/7.7.*

## contents / table des matières

### Feature Articles / Articles de fond

- 188 **Towards an Intellectual Genealogy of Canadian Astronomers**  
*by Richard A. Jarrell*
- 193 **Avoiding Battery Brownout: Tips for Astronomers**  
*Peter D. Hiscocks*
- 200 **Thomas Digges's Perception of Stellar Sizes and Distances**  
*by Peter D. Usher*
- 223 **Answers to August's Quasar Crossword**  
*by Naomi Pasachoff*

### Columns / Rubriques

- 201 **Pen and Pixel: eta Carina / "Sparky" / M16 area / Cocoon Nebula / Vertical Milky Way / Cassiopeia Reflection / Girl in a Red Dress / Iris Nebula**  
*Jack Newton / Ron Berard / Klaus Brasch / Howard Trottier / Mark Burnell / Lynn Hilborn / Sheila Wiwchar / Jay Anderson*
- 208 **Orbital Oddities: Trying for the Tetrad**  
*by Bruce McCurdy*
- 211 **Perception and Reflection: The Earliest Image of Sunspots?**  
*R.A. Rosenfeld*
- 214 **John Percy's Universe: Adventures in School Astronomy**  
*by John R. Percy*
- 217 **Fun With Arduinos—Part 3: Anti-Dew Heat Control by Arduino**  
*by Rick Saunders*
- 220 **Second Light: Things That Go Bang in the Night**  
*by Leslie J. Sage*

### Departments / Départements

- 184 **News Notes/En manchettes**  
*Compiled by Andrew I. Oakes*
- Alien planet confirmed as a "super-Earth"
  - Canadian-built technology to image asteroid for sample scoop
  - Longest year to date recorded for Uranus-like exoplanet
  - Highest priority in ground-based astronomy proceeding in Chile and Hawaii
  - Comet-chasing spacecraft reaches target
- 182 **President's Corner**  
*by James Edgar*
- 183 **RASC General Assembly Photos**  
*(continues on page 222)*
- 221 **Reviews/Critiques**  
*By Chris Gainor*
- 223 **A Note from the 2014 General Assembly Organizing Committee**  
*By Mark Bohlman and Paul Schumacher*
- 224 **Astrocryptic and August Answers**  
*by Curt Nason*
- 224 **It's Not All Sirius**  
*by Ted Dunphy*
- iii **Great Images**  
*by James Black*

Front Cover — Lynn Hilborn seeks out the unusual and has focused on an area of the sky that seldom gets much attention—the region around Polaris, the North Star. This image, captured with an ML 8300 camera using a 135-mm lens at  $f/2.5$ , shows the star and its background of galactic cirrus. Galactic cirrus is the filamentary material seen throughout this image and is the visible-light traces of tenuous dust and gas within the Milky Way. Lynn used exposures of 38×4 minutes in L, 18×10 m in R, and 12×10 m in B for this 7½ hour image.



# Journal

The *Journal* is a bi-monthly publication of The Royal Astronomical Society of Canada and is devoted to the advancement of astronomy and allied sciences.

It contains articles on Canadian astronomers and current activities of the RASC and its Centres, research and review papers by professional and amateur astronomers, and articles of a historical, biographical, or educational nature of general interest to the astronomical community. All contributions are welcome, but the editors reserve the right to edit material prior to publication. Research papers are reviewed prior to publication, and professional astronomers with institutional affiliations are asked to pay publication charges of \$100 per page. Such charges are waived for RASC members who do not have access to professional funds as well as for solicited articles. Manuscripts and other submitted material may be in English or French, and should be sent to the Editor-in-Chief.

## Editor-in-Chief

Jay Anderson  
203 – 4920 Dundas St W  
Toronto ON M9A 1B7, Canada  
Email: editor@rasc.ca  
Web site: [www.rasc.ca](http://www.rasc.ca)  
Telephone: (416) 924-7973  
Fax: (416) 924-2911

## Associate Editor-in-Chief

Nicole Mortillaro  
Email: nmortillaro@gmail.com

## Associate Editor, Research

Douglas Hube  
Email: dhube@phys.ualberta.ca

## Associate Editor, General

Michael Attas  
Email: attasm@aecl.ca

## Assistant Editors

Michael Allen  
Martin Beech  
Dave Chapman  
Ralph Chou  
Ralph Croning  
Dave Garner  
Patrick Kelly  
Gail Wise

## Editorial Assistant

Suzanne E. Moreau  
Email: semore@sympatico.ca

## Production Manager

James Edgar  
Email: james@jamesedgar.ca

## Contributing Editors

Jim Chung (Cosmic Contemplations)  
John Crossen (Rising Stars)  
Ted Dunphy (It's Not All Sirius)  
Geoff Gaherty (Through My Eyepiece)  
Dave Garner (On Another Wavelength)  
Blair MacDonald (Imager's Corner)  
Curt Nason (Astrocryptic)  
Andrew I. Oakes (News Notes)  
John R. Percy (John Percy's Universe)  
Randall Rosenfeld (Art & Artifact)  
Leslie J. Sage (Second Light)  
Rick Saunders (Cheap Stuff From China)  
David Turner (Reviews)

## Proofreaders

Ossama El Badawy  
Margaret Brons  
Angelika Hackett  
Terry Leeder  
Kim Leitch  
Suzanne Moreau

## Design/Production

Michael Gatto, Grant Tomchuk  
Email: gattotomatto@eastlink.ca,  
granttomchuk@eastlink.ca

## Advertising

Email: mempub@rasc.ca

## Printing

Canselmdc  
[www.cansel.ca](http://www.cansel.ca)

The *Journal* of The Royal Astronomical Society of Canada is published at an annual subscription rate of \$93.45 (including tax) by The Royal Astronomical Society of Canada. Membership, which includes the publications (for personal use), is open to anyone interested in astronomy. Applications for subscriptions to the *Journal* or membership in the RASC and information on how to acquire back issues of the *Journal* can be obtained from:

The Royal Astronomical Society of Canada  
203 – 4920 Dundas St W  
Toronto ON M9A 1B7, Canada

Email: [nationaloffice@rasc.ca](mailto:nationaloffice@rasc.ca)  
Web site: [www.rasc.ca](http://www.rasc.ca)  
Telephone: (416) 924-7973  
Fax: (416) 924-2911



Canadian Publications Mail Registration No. 09818

Canada Post: Send address changes to 203 – 4920 Dundas St W, Toronto ON M9A 1B7

Canada Post Publication Agreement No. 40069313

We acknowledge the financial support of the Government of Canada through the Canada Periodical Fund (CPF) for our publishing activities.

Canada

© 2014 The Royal Astronomical Society of Canada.

All rights reserved. ISSN 0035-872X



## President's Corner



by James Edgar, Regina Centre

([james@jamesedgar.ca](mailto:james@jamesedgar.ca))

The General Assembly in Victoria was well attended and a resounding success, as can be seen by some of the photos captured during the event. The Victoria Centre members did a bang-up job running the show, arranging for smooth transitions between waking up, attending meetings, gathering for meals, and having a good time. The venues, speakers, and panels were all excellent choices. Well done, Victoria!

One of the first things I did as President after returning home (apart from contending with extreme flooding in and around Melville) was to initiate a working group to search for a new Executive Director. Deborah Thompson, the former ED, has moved on to a new position with another non-profit group in Toronto, and we are actively engaged in interviews and assessments to re-fill that role. We thank Deborah for her dedication and hard work during her four years at the helm of our Society. We will truly miss her.

The Board of Directors is meeting several times over the coming months, mostly by electronic means, plus we plan to re-visit our Strategic Plan during a three-day retreat in early October in Toronto. We fully expect to address the many major issues within the RASC such as publication sales, membership retention, upcoming events, public outreach (our whole reason for existence), and engaging volunteers.

With that in mind, the Board has approved the content of a new *Getting Started in Astronomy* booklet, written by Gary Seronik and published as a joint effort with *SkyNews*. The printing run has begun as I write this—it includes 30,000 copies for the RASC to distribute to Centres for use at outreach events and 25,000 copies for *SkyNews*.

We have begun to see interest in our new sponsorship program, with three new sponsors signed up. Their logos and links are evident on each page of the RASC Web site: Starry Night, Melita Trips, and Ontario Telescopes will receive prominent recognition in our publications and on the Web. We have others interested in the program, so stay tuned for further developments.

Clear skies! ✨



Figure 1 — Incoming President James Edgar with Bob McDonald, former host of the CBC's Quirks and Quarks. Photos (all): James Edgar



Figure 2 — Nathan Gray, winner of the Chilton Prize along with his sister Kathryn Gray, stands with Bob McDonald of Quirks and Quarks fame.



Figure 3 — Ray Khan of Khan Scope Centre meets "Royalty" at the Victoria GA.

Compiled by Andrew I. Oakes

## Alien planet confirmed as a “super-Earth”

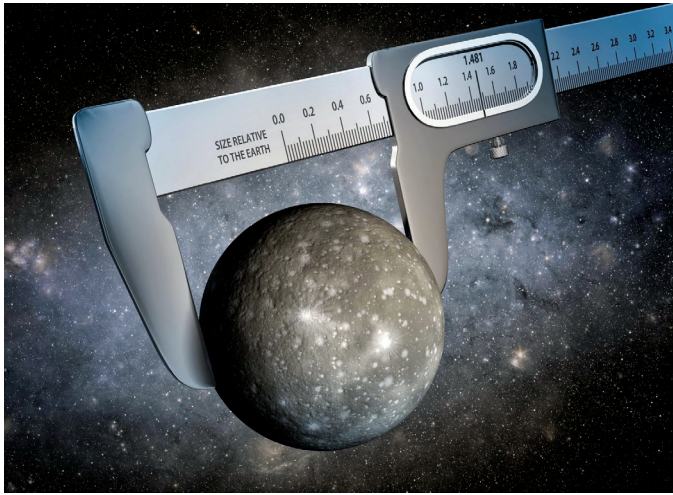

Figure 1 — Kepler-93b has a planetary diameter of about 18,800 kilometres.

Astronomers recently succeeded in precisely measuring the diameter of Kepler-93b, an alien world located in deep space, well beyond our Solar System. The exoplanet is now confirmed to be a “super-Earth,” sporting a planetary diameter of about 18,800 kilometres with a standard error of 240 kilometres, an uncertainty of just one percent. The exoplanet has a diameter that is 1.481 times that of the Earth.

Data from NASA’s *Kepler* and *Spitzer Space Telescopes* helped to determine the more exact planetary size. As for its actual mass, previous measurements using the ground-based Keck Observatory in Hawaii established Kepler-93b’s mass at about 3.8 times that of Earth. The combination of Kepler-93b’s mass and the newly obtained radius indicates that the planet is very likely made of iron and rock, like the Earth. According to emerging astronomical observations, such super-Earths are common in the Milky Way.

Considered to be too hot for life, Kepler-93b’s orbital distance from its star—about one-sixth that of Mercury’s from the Sun—points to a surface temperature of around 760 °C.

As a newly defined planet of a major class, Kepler-93b offers a convenient laboratory for scientists to study super-Earth exoplanets. With measured, precise limits, on planetary sizes and masses, astronomers can begin to hypothesize about what makes up these alien worlds.

“With *Kepler* and *Spitzer*, we’ve captured the most precise measurement to date of an alien planet’s size, which is critical for understanding these far-off worlds,” said Sarah Ballard, a NASA Carl Sagan Fellow at the University of Washington in

Seattle and lead author of a paper on the findings published in the *Astrophysical Journal* in July 2014.

NASA’s Jet Propulsion Laboratory in Pasadena, Calif., manages the *Spitzer Space Telescope* mission for NASA’s Science Mission Directorate, Washington. Science operations are conducted at the Spitzer Science Center at the California Institute of Technology in Pasadena.

## Canadian-built technology to image asteroid for sample scoop



Figure 2 — Artist’s view of NASA’s Origins Spectral Interpretation Resource Identification Security Regolith Explorer (OSIRIS-REx). Image: Lockheed Martin.

A team of five Canadian scientists is working with a global communications and information space-technology company to build and test a new tool called the *OSIRIS-REx* Laser Altimeter (OLA), which will fly aboard NASA’s unmanned *OSIRIS REx* spacecraft. The laser altimeter is an advanced lidar (Light Detection and Ranging) system. It is a hybrid of the lidar on the Canadian weather station aboard NASA’s *Phoenix Mars Lander*, and an instrument flown on the 2005 US Air Force *Experimental Satellite System-11 (XSS-11)*. The Canadian-made device will take 160 million measurements of asteroid Bennu, a small body that is about 500 metres in diameter. The laser technology will generate an accurate 3-D map of the asteroid that will assist scientists in choosing the best site to collect a sample with the spacecraft’s cutting-edge robotic arm.

*OSIRIS-REx* will launch in September 2015 and reach Bennu, a carbonaceous asteroid, in November 2018. The spacecraft will study Bennu’s geology for about eight months and then

return to Earth in 2023 after collecting a sample from the asteroid's surface. Once the sample location is chosen, the spacecraft will approach the surface and—without landing—extend its robotic arm to collect at least 60 g of material from the asteroid's surface.

Bennu (1999 RQ<sub>36</sub>), formerly known as Near-Earth Object (NEO) 101955, is an accessible, volatile, and organic-rich remnant from the early Solar System with a one-in-2700 risk of impacting Earth in about 200 years. Through previous telescopic observations, the asteroid is known to be rich in carbon, unusually dark in colour, and unlike any samples in meteorite collections. The asteroid is circularly symmetric in shape, like a spinning top. Its shape probably formed when the asteroid rotated fast enough for rocks to tumble from its poles to pile up at its equator.

The space mission will help scientists investigate matter made of original, primal material left over after the epoch planets formed, providing new information in such critical areas as:

- Formation of Sun's planets and Solar System;
- Origin of water and organic material on Earth;
- Fundamental data on the asteroid's shape, topography (distribution of boulders, rocks, and other surface features), surface processes, and evolution;
- Magnitude measurement of the "Yarkovsky effect" (how sunlight can alter Bennu's orbit over time);
- Provide an enhanced understanding of Bennu's motion to define better its orbit and more accurately predict its chances of collision with Earth; and
- Improve the overall understanding of asteroids that could impact Earth.

The Canadian scientific team for the OLA component of the mission is being led by Dr. Alan Hildebrand of the University of Calgary. The other four Canadian team members include Dr. Michael Daly from York University (serving as the deputy principal investigator and instrument scientist for OLA); Dr. Ed Cloutis, University of Winnipeg; Dr. Rebecca Ghent, University of Toronto; and Dr. Catherine Johnson, University of British Columbia.

In return for Canada's contribution through the CSA, Canada's space agency will receive four percent of the asteroid sample for its scientists to study. The Canadian team will analyze Canada's part of the sample for such properties as:

- Bulk and grain density;
- Elasticity;
- Dielectric properties (or how the sample interacts with electromagnetic radiation); and
- Shear and tensile strength.

The tentative plan is to curate the Canadian portion of the returned asteroid sample at the University of Calgary.

Funding for Canada's *OSIRIS-REx* Laser Altimeter is being provided through the Canadian Space Agency (CSA) and amounts to \$61 million for the mission, including a \$9-million contract to construct the laser system in Canada. NASA is investing \$800 million in this multi-year mission (excluding the launch vehicle). MacDonald, Dettwiler and Associates Ltd. (MDA), a leading Canadian technology company and the prime contractor for the CSA—together with MDA's industrial partner, Optech—designed and will build and test the *OSIRIS-REx* Laser Altimeter.

## Longest year to date recorded for Uranus-like exoplanet

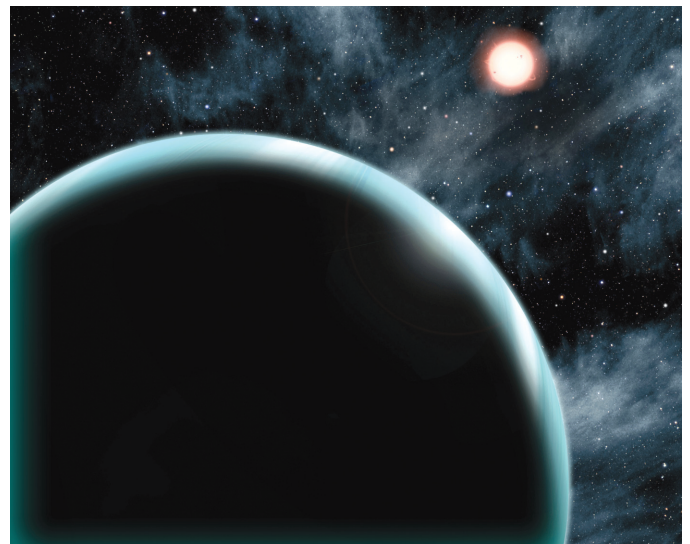

Figure 3 — An artist's concept of Kepler-421b, orbiting an orange, K-type star. Image: Harvard-Smithsonian Center for Astrophysics/D. A. Aguilar

In another *Kepler Space Telescope* success, astronomers have identified a distant alien world with an orbit of 704 Earth-days around its host star. To date, this orbital period represents the longest "year" of any planet in the more than 1800 already confirmed worlds beyond the Solar System.

The exoplanet, known as Kepler 421-b, is estimated to be Uranus-sized and some 1040 light-years away. Data from *Kepler* allowed astronomers to conclude that the planet orbits an orange host star—cooler and dimmer than Earth's Sun—at a distance of 177 million km, about 1/6th larger than the Earth's orbit. Kepler-421b is known to be outside the "snow line"—a line in space that divides rocky planets like Earth from the gas giants like Jupiter. It is also beyond the limit at which water condenses into ice grains that stick together to build gas planets, a crucial distance in planetary formation theory. A study to be published in the *Astrophysical Journal* indicates that the average temperature of Kepler421-b is around  $-93^{\circ}\text{C}$ .

According to David Kipping of the Harvard-Smithsonian Center for Astrophysics in Cambridge, USA, and the study's lead author, finding Kepler-421b was a lucky event, since the farther a planet is from its star, the less likely it is to transit from Earth's point of view.

The *Kepler Space Observatory* detected only two transits of Kepler-421b due to the planet's long orbital period. The transit technique looks for periodic dips in light as exoplanets pass in front of their host stars. Because gas giants are usually found extremely close to their stars, orbiting in days or even hours, current theory suggests that many exoplanets migrate inward early in their history. Significantly, Kepler-421b demonstrates that an inward planetary migration is not always necessary; the planet likely formed exactly where it currently lies.

## Highest priority in ground-based astronomy proceeding in Chile and Hawaii



Figure 4 — An artist's concept of the completed E-ELT observatory. Image: ESO.

Major developments this past summer have moved forward the planned construction of two massive ground-based optical telescopes, one to be located in northern Chile and the other in Hawaii.

Site preparation crews in Chile levelled the mountaintop location of the future European Extremely Large Telescope (E-ELT) to be constructed atop the 3060-metre Cerro Armazones Mountain.

The blasting operation at the summit loosened some 5000 cubic metres of rock, marking the start of what will be the world's largest optical telescope, a project of the European Southern Observatory (ESO).

Featuring a 39-metre mirror—the world's biggest ground-based eye-on-the-sky—the telescope with its suite of instruments will allow astronomers to advance the study of:

- Supermassive black holes;
- Exoplanets—planets around other stars; as well as
- Probe the earliest stages of the formation of planetary systems;
- Detect water and organic molecules in proto-planetary discs around stars in the making;
- Zero in on the very first objects in the Universe;
- Examine the nature and distribution of dark matter and dark energy;
- Explore completely yet-unknown features of the Universe; and
- perhaps bring humanity one step closer to answering the question: Are we alone?

The European Extremely Large Telescope will gather 100 million times more light than the human eye; 8 million times more than Galileo's telescope; and more light than all of the existing 8–10-metre-class telescopes on the planet, combined. The primary mirror will consist of almost 800 segments, each 1.4 metres wide, but only 50 mm thick. It will incorporate an immense secondary mirror, 4.2 metres in diameter, which itself is bigger than the primary mirrors of any of ESO's telescopes at La Silla, in the southern part of the Atacama Desert.

The E-ELT telescope incorporates adaptive mirrors that will compensate for the fuzziness in the stellar images introduced by atmospheric turbulence. Each one of the mirrors is supported by more than 6000 actuators that can distort its shape 1000 times per second.

Several science instruments will be attached to the telescope, making it possible for astronomers to switch from one instrument to another within minutes. Both the telescope and its hemispherical dome will be capable of changing positions on the sky and starting a new observation in a very short time.

The ESO has been working together with its user community of European astronomers and astrophysicists since the end of 2005 to define the new, giant telescope. More than 100 astronomers from all European countries have been involved in helping the ESO Project Offices to produce a novel concept in which performance, cost, schedule, and risk were carefully evaluated. The Chilean-located E-ELT is expected to be completed by 2024.

Meanwhile, out in the Pacific Ocean, the University of Hawaii approved a plan to lease land from the State of Hawaii at the summit of Mauna Kea, a dormant volcano that already hosts about a dozen telescopes. This new site will host the Canadian-designed Thirty-Metre Telescope (TMT).

Construction of the \$1.3-billion telescope is expected to begin later this year, with operations scheduled to start in 2021, some



three years ahead of the Chilean project. The telescope would be used to observe planets that orbit stars outside our own Solar System and would enable astronomers to watch new planets and stars being formed.

Featuring a segmented primary mirror nearly 30 metres in diameter, the Hawaii-based telescope will dwarf the world's current largest optical telescope, the *Gran Telescopio Canarias* located on Spain's Canary Islands. That instrument is a 10.4-metre telescope with a segmented primary mirror. The TMT's large aperture, with about nine times the light-gathering capacity of the *Gran Telescopio Canarias*, will allow images of fainter objects and reach further into the Universe than its Canary Island precursor.

The University of California, the California Institute of Technology, and the Association of Canadian Universities for Research in Astronomy initiated the project; observatories and institutions in China, India, and Japan later signed on as partners. A Port Coquitlam, B.C., firm, Dynamic Structures Ltd., has designed and will construct the enclosure.

## Comet-chasing spacecraft reaches target

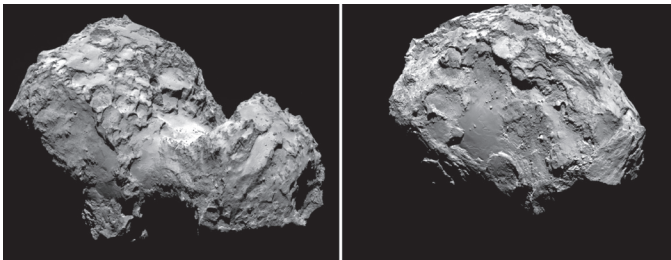

Figure 5 — Close-up images of 67P/Churyumov-Gerasimenko taken 2014 August 6. Image: ESA.

The European Space Agency's (ESA) comet-chasing spacecraft, *Rosetta*, rendezvoused with its target on 2014 August 6 after a decade-long journey. *Rosetta*'s speed and trajectory now match those of comet 67P/Churyumov-Gerasimenko. At the point of rendezvous, the spacecraft found itself 100 kilometres from the comet's surface, a distance it will maintain for the first 6 weeks before dropping downward to 50 kilometres. *Rosetta* is expected eventually to attempt a close, near-circular orbit of 30 kilometres and may get even closer.

During the first two-altitude period, *Rosetta* will fly two triangular-shaped trajectories in front of the comet while at the same time making a detailed scientific study of 67P. It will also scan the surface to identify a target site for its comet lander, *Philae*.

The comet has an elliptical orbit of 6.5 years, which takes it from beyond Jupiter at its farthest point to between the orbits

of Mars and Earth at its closest to the Sun. The spacecraft will accompany the comet for over a year as it swings around the Sun and back out towards Jupiter. At the time of rendezvous, comet 67P/Churyumov-Gerasimenko and *Rosetta* were about halfway between the orbits of Jupiter and Mars.

Mission planners expected to identify as many as five possible landing sites by late August and the primary site by mid-September. Deployment of the *Philae* landing probe is planned for mid-November 2014. The probe is expected to obtain the first images taken from a comet's surface and provide the first analysis of a comet's composition by drilling into the surface.

As well, *Rosetta* itself will be the first spacecraft to witness at close range how a comet changes as it is subjected to the increasing intensity of the Sun's radiation.

*Andrew Oakes is a Contributing Editor to the Journal who lives in Courtrice, Ontario. \**

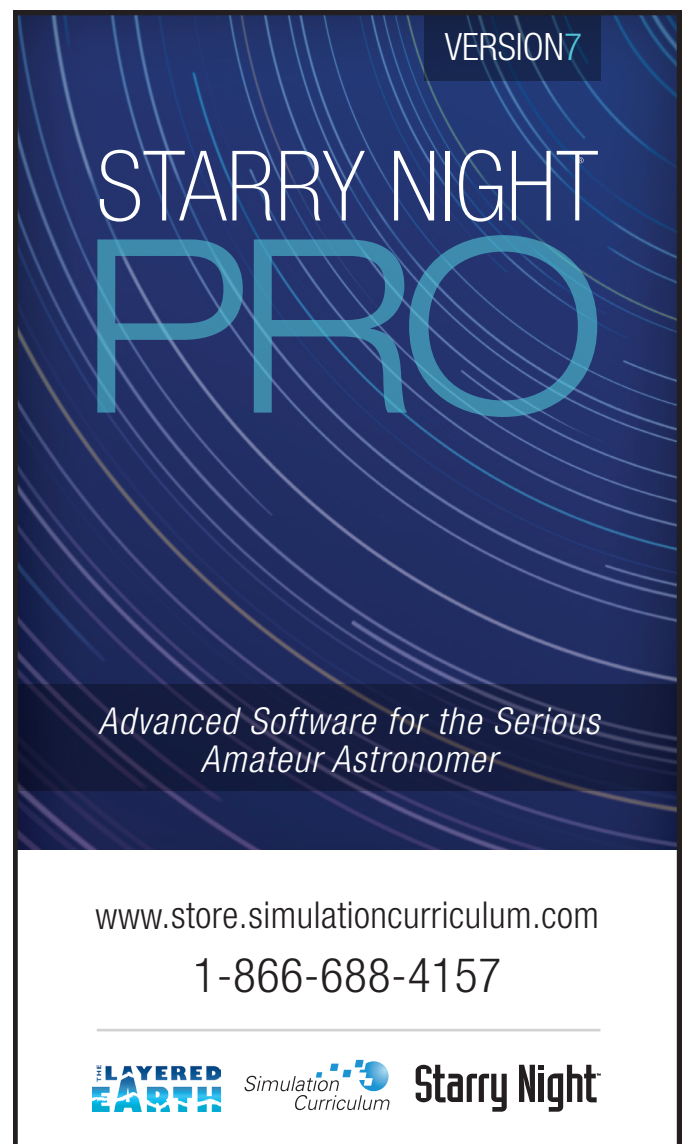

VERSION 7

# STARRY NIGHT PRO

Advanced Software for the Serious  
Amateur Astronomer

www.store.simulationcurriculum.com  
1-866-688-4157

THE LAYERED EARTH Simulation Curriculum Starry Night

## Towards an Intellectual Genealogy of Canadian Astronomers

Richard A. Jarrell, York University [deceased]<sup>1</sup>

### Abstract

We present an overview of the Astronomy Genealogy Project (AstroGen), which is being undertaken by the Historical Astronomy Division of the American Astronomical Society. Examples from Canada are used to illustrate some of the opportunities and pitfalls.

### Résumé

Nous présentons un aperçu du projet Généalogie astronomique (AstroGen) entrepris par la Division d'astronomie historique de l'American Astronomical Society. Des exemples provenant du Canada illustrent quelques possibilités et embûches.

### Introduction

Early in 2013, the Historical Astronomy Division (HAD) of the American Astronomical Society agreed to create an astronomy genealogical project (AstroGen; <http://had.aas.org/astrogen/>) with the ambitious goal of obtaining educational information about astronomers worldwide and as far back in time as possible. With this information, it will be possible to show in a graphic way a particular astronomer's intellectual "forebears" and his or her intellectual "progeny" in much the same way genealogists construct family trees. The HAD plan is based upon the successful Mathematics Genealogy Project (MGP) of the American Mathematical Society, hosted at North Dakota State University (<http://genealogy.math.ndsu.nodak.edu/>). This program has been underway since 1996 and now has more than 180,000 records. By being inclusive and interpreting mathematics broadly, the MGP captures a sizable number of astronomers, particularly before the 20th century, when an astronomer was more likely to be trained by a mathematician than by another astronomer or a physicist. It also has a great many physicists.

Following the MGP's lead, we will create a Web site in which one can search for a particular astronomer and find who were his or her supervisor(s) or mentor(s), the type of degree, year, and institution, and title of dissertation. We can also see the astronomer's students. Where we can, we want also to be able to provide more information, such as years of birth and death.

This extra information will help distinguish between astronomers with identical or near-identical names.

Anyone who has dealt with real genealogy knows how difficult it can be to obtain solid information earlier than two generations in the past. It is unlikely that many readers of this journal could even name all sixteen of their great-great-grandparents, much less their dates and where they were born. Some people find genealogy utterly fascinating, others have complete indifference to it. For some, genealogy is a means of identifying genetic heritage. Suppose your great-great grandmother was a member of the Dutch royal family. While you might take great pride in this fact, you share only 1/16 of the genes of your noble ancestor. Does such watered-down genetic heritage mean very much? In most cases, no, although in highly inbred families such as the Spanish Hapsburgs, genetic traits (the Hapsburg chin) did survive many generations, with a tragic ending. More important in most families—unless we are talking about passing on noble titles or vast fortunes—are the cultural characteristics of a family such as religion, class, social linkages, and habits that might persist for many generations. It is this latter kind of inheritance that the MGP and AstroGen highlight. How long do characteristic attitudes about science and academic behaviour survive? Are there particular approaches to scientific problem solving that persist over generations? Are certain research domains handed down from supervisor to student and to the student's students?

### Problems with Building a Database

The advantage we will have in AstroGen is that we have let the mathematicians discover the problems and pitfalls, which we can hopefully avoid. At the beginning, the MGP founders had to decide upon the software, the temporal and geographical limitations (if any), and conventions for what data was to be

The screenshot shows the Mathematics Genealogy Project website. The main heading is "Mathematics Genealogy Project". Below it, the entry for "Leonhard Euler" is displayed. The entry includes his biography, his Ph.D. from Universität Basel in 1726, his dissertation "Dissertatio physica de sono", and his advisor Johann Bernoulli. A table lists his students and their descendants. The table has three columns: Name, School, and Year Descendants. The students listed are Johann Euler, Nicolaus Fuss, Johann Hennert, Semen Kotelnikov, Joseph Lagrange, and Stepan Rumovsky. The number of descendants for Johann Hennert is 4374, and for Joseph Lagrange is 79922. Below the table, it states: "According to our current on-line database, Leonhard Euler has 6 students and 83318 descendants. We welcome any additional information."

Name	School	Year Descendants
Johann Euler		
Nicolaus Fuss	St. Petersburg Academy	
Johann Hennert	Königliche Akademie der Wissenschaften zu Berlin	4374
Semen Kotelnikov	Universität Berlin	
Joseph Lagrange		79922
Stepan Rumovsky	Universität Berlin	

Figure 1 — Leonhard Euler's entry in the Mathematical Genealogy Project. <http://genealogy.math.ndsu.nodak.edu/id.php?id=38586>.

sought and verified. An example of a typical page, that of the mathematician and astronomer Leonhard Euler, is shown in Figure 1.

As the MGP's Web site notes, a full entry would contain:

- 1) the complete name of the degree recipient,
- 2) the name of the university which awarded the degree,
- 3) the year in which the degree was awarded,
- 4) the complete title of the dissertation, and
- 5) the complete name(s) of the advisor(s).

In the 20th and 21st centuries, the degree would usually be a doctorate (Ph.D., D.Sc., *etc.*) and the advisor would be the dissertation supervisor. As we probe earlier and earlier, types of degrees will change. There were no doctorates in the modern sense in the 18th century; dissertations were quite unlike what we recognize today, and the term supervisor did not have the modern meaning. In some cases, the term “mentor” might be preferable, particularly when an astronomer's key influence might have been an undergraduate teacher or an observatory director who was not a teacher *per se*.

Geography is always an issue. On MGP pages, a flag of the modern nation is displayed. For instance, on Carl Friedrich Gauss's page, a modern German flag is shown, although Germany did not exist in his time. MGP staff also found that there were difficulties in spelling of names, titles of theses, and correct dates. The AstroGen team, which is wrestling with a number of decisions as to what to include, has already decided that there will be no flags.

Once decisions are made regarding the information to put in the database, the single greatest problem will be data collection. Neither the MGP nor, presumably, AstroGen, will have a paid team of researchers. Volunteers build and maintain the MGP site, and data are sent in by individuals. Data are only as good as what individuals provide, and not all data can be verified in a timely manner. Donations, small grants, and a sympathetic Web site host allow for the MGP's continued existence. In a way, such a project is something like a shoestring Wikipedia operation.

## Tracking the Early Canadian Astronomers

In contemporary astronomy, we know what an astronomer is in terms of training and professional position. During the 19th century, these are not so obvious. Take, for example, Canada's three first professional government astronomers: William F. King (1854–1916); Otto Julius Klotz (1852–1923); and Édouard-Gaston Daniel Deville (1849–1924). They were all involved in astronomy primarily through surveying—King and Klotz became Chief Astronomers and Deville was Surveyor-General—and they were professional in the sense

that they earned a living through their science. King was an early student of John Bradford Cherriman (1823–1908) at the University of Toronto. Cherriman was a mathematician, although he did direct the Toronto Magnetic and Meteorological Observatory for a short time. However, Cherriman is not in the MGP database despite having been 6th wrangler in the mathematical tripos at Cambridge in 1845, which was no small feat. He was trained at St. John's College, Cambridge, and one would have to search college records to discover who Cherriman's mathematics mentor or tutor was. Thus, from King, we can go back only one step.

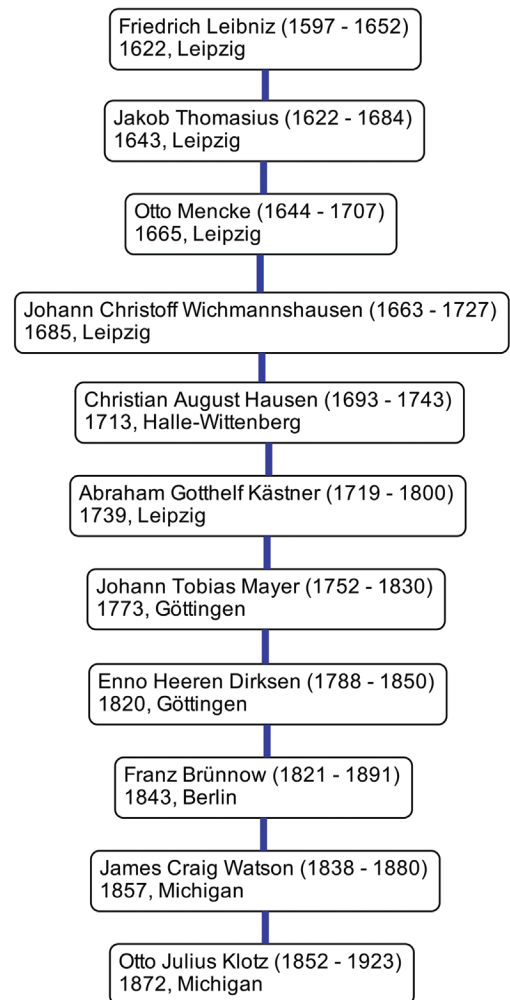

Figure 2 — Klotz's academic ancestry (graphic by J.S. Tenn).

Deville's education was at the French Naval Academy in Brest (École navale), which would not likely lead to a notable astronomer or mathematician. It would take some digging to discover who his instructors were. In Klotz's case, he was trained by an astronomer, Canadian-born James Craig Watson (1838–1880), at the University of Michigan. Watson is listed in the MGP as receiving a Dr.Phil. from the University of Leipzig in 1870 for a dissertation entitled “Theoretical Astronomy relating to the motion of heavenly bodies.” The page states “advisor unknown” and “no known students.” Here is the problem of too little information. The Dr.Phil. was, in



Figure 3 — Otto Julius Klotz (William James Topley/Library and Archives Canada)

fact, a honorary degree for his textbook, *Theoretical Astronomy* (published in 1868) and his asteroid discoveries. Apart from Klotz, he had at least two noteworthy students: John M. Schaeberle; and C.G. Comstock. Watson's teacher was Franz Brünnow (1821–1891), the first director of the Detroit Observatory in Ann Arbor. Brünnow is in the MGP and from his page we can construct Klotz's intellectual family tree with each generation of teacher, where and when they graduated (Figure 2).

We can trace Klotz's intellectual ancestry back ten generations to Friedrich Leibniz, the father of the great mathematician Gottfried Leibniz, before we reach a dead end. Klotz (Figure 3) would probably have been pleased if he had known any of this. But, Klotz, like his colleagues King and Deville, was not a professor and thus had no intellectual "offspring" in the ordinary sense. This might be a hint that we need to broaden our sense of intellectual genealogy, because all three of these men, but especially King, had an influence upon younger colleagues and co-workers and acted as mentors.

Academic astronomers were relatively rare in the 19th century, particularly in Canada. William Brydone Jack (1817–1886), who built one of Canada's earliest observatories, at the University of New Brunswick, was a student of the noted physicist David Brewster at St. Andrew's University. But, Brewster was effectively self-taught in science, so we meet another dead end. At Queen's University, James Williamson (1806–1895) taught astronomy and directed the observatory; he was an Edinburgh graduate and a student of mathematician Walter Nichol. Williamson's successor was his student Nathan

F. Dupuis (1836–1916), whose best-known student was Samuel Alfred Mitchell (1874–1960) of the University of Virginia. Some diligent footwork could probably extend the lines from Williamson in both directions.<sup>2</sup>

## C.A. Chant's Many Children

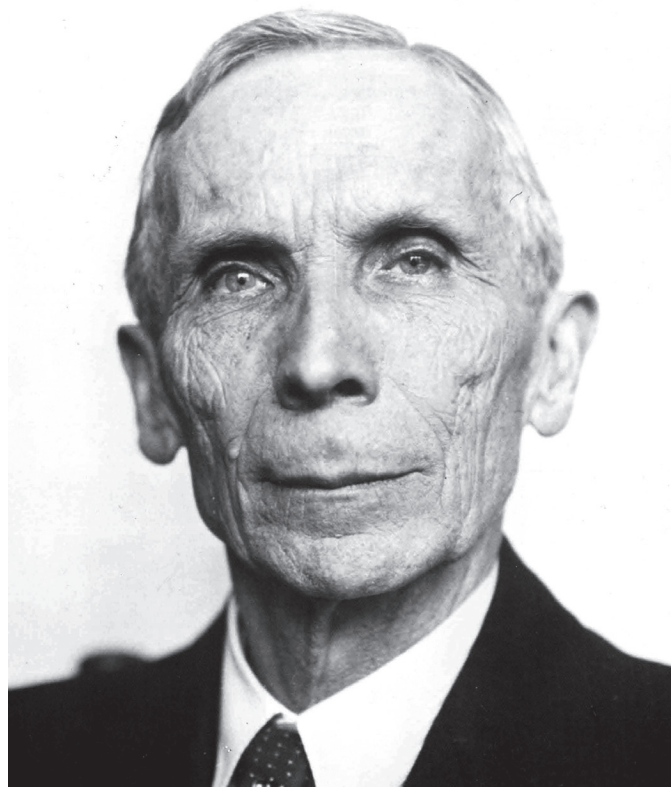

Figure 4 — Clarence Augustus Chant (University of Toronto)

The modern era of Canadian astronomical education commenced with Clarence Augustus Chant (1865–1956; Figure 4) at the University of Toronto. His training was in the traditional mathematics and physics courses. His mathematics instructor, who taught a course on astronomy, was Alfred Baker (1848–1942). In physics, James Loudon (1841–1916), later president of the university, was his instructor. J.S. Plaskett had the same teachers. Both Baker (B.A. 1875) and Loudon (B.A. 1862) were students of Cherriman, so we are back to the brick wall for now. Chant launched astrophysics at the university in the first decade of the 20th century and began turning out a long string of students, some co-taught by his later assistant and former student Reynold K. Young (1886–1977).

Chant had an impressive list of students over a nearly 40-year teaching career. At least 14 students became astronomers (Table 1). Young would also be involved with any students from 1924, when he arrived from the Dominion Astrophysical Observatory (DAO). This list shows where the students spent their astronomical career. Many of Chant's students formed the early core of the staff at the Dominion Observatory (DO) in Ottawa.

Students of Clarence Augustus Chant
H.F. Balmer (Buffalo Science Museum)
J.B. Cannon (DO)
W.E. Harper (DO, DAO)
J.P. Henderson (DO)
Ernest Hodgson (DO)
F.S. Hogg (DAO, Toronto)
R.J. McDiarmid (DO)
Peter Millman (Toronto, DO, NRC)
Robert M. Motherwell (DO)
Ruth J. Northcott (Toronto)
T.H. Parker (DO)
J.A. Pearce (DAO)
H.H. Plaskett (DAO, Oxford)
R.K. Young (Kansas, DAO, Toronto)

Table 1

There was no graduate program until right at the end of Chant's tenure, so almost all of these students took a bachelor's degree. Some went on for a Ph.D. elsewhere: Hogg and Millman to Harvard, Young and Pearce to California, McDiarmid to Princeton. That would add another layer of mentors. Toronto's Department of Astronomy launched in the 1930s, but staff was small, graduate students few, and they studied only for the M.A. degree. With the 1950s, the Ph.D. program was created, and the list of graduates since then is quite impressive. As the university's astronomy and astrophysics library has a reasonably complete collection of theses and dissertations, a few days' research would provide data to create a number of lines of descent from Chant and Young.<sup>3</sup>

Despite this impressive list of offspring, only four were directly involved in teaching astronomy. Young taught 22 years, Millman 7, and Northcott 25 at the University of Toronto. Millman moved into the civil service after World War II, and Northcott taught mostly undergraduates. She certainly would be considered a mentor to many students but not the supervisor, which underscores one problem in the methodology. Plaskett taught 32 years at Harvard and Oxford.

## Is Astronomy in Canada Different?

Universities are involved in production—research and publication—and in reproduction, the formation of new generations of researchers and teachers. Each science has its own distinctive pattern. Astronomy is very different from chemistry, for example; reproduction for chemistry means a significant annual cohort of Ph.D.s destined for teaching posts in colleges and universities as virtually every institution that teaches science teaches chemistry. Still, most of chemistry's reproduc-

tion goes into graduating research chemists for industry and government as it has for many decades. Astronomers have far fewer academic posts available to them at any time, nor do they have many opportunities in industry or government. Until the 1970s, the number of jobs open to astronomers in North America was very limited.

Looking at Chant's list of graduates, we can see that few went directly into academic careers. Only Frank Hogg went directly to the Ph.D. and then to Toronto after a short sojourn at the DAO. Young had a brief teaching stint at the University of Kansas but spent several years in Victoria before an opening was available as Chant's assistant. Millman taught at Toronto only seven years before war service and a move to the civil service. Harry Plaskett ended up in Oxford after detours through the DAO and Harvard. Balmer worked in a science museum. All the rest went into government service, either at the DO or the DAO, or both. In fact, if we follow the MGP scheme, Chant would have only four academic descendants in the next generation, if we discount Millman's brief teaching career.

What this suggests is that there are real national differences in the employment patterns of astronomers. Before the 1960s, Canadian astronomers were far more likely to be employed by government agencies than by universities. Few Canadian universities even taught astronomy and only Toronto had a department. Emigration was the only other option if a graduate wanted to remain in astronomy. By contrast, American universities had long taught astronomy and a number of universities maintained departments and observatories. However, apart from the U.S. Naval Observatory, government positions in pre-NASA times were very rare. The pattern in pre-1960 France and the Soviet Union would likely be similar to Canada's. A genealogical reconstruction could show national patterns and how they have changed over time.

We can also see this pattern in sub-disciplines. As radio astronomy expanded in Canada, almost all positions were at the National Research Council or at the Dominion Observatory. Radio astronomers at universities were a rarity until relatively recently.

Given this pattern in Canada, we can see that reproduction was long biased towards producing government scientists, not professors. This meant a much smaller core of teaching staff educated the following generations. Traditionally, students are attracted to supervisors because of the research interests of the latter. A smaller teaching core might then translate into a narrower range of research production. Using the genealogy, one could quickly track the subject matter of dissertations to see whether that has been the case. We would expect the American pattern to be different given the much larger core of teaching professionals. Another test of student interest would be to track Canadian-born students who took their degrees outside Canada.

## Next Steps

Mathematicians have probably always outnumbered astronomers by a considerable factor, but if HAD hopes to encompass as many astronomers as possible, it has a daunting task ahead of it if we consider it even to be a fraction of the size of the MGP's large database. And, it is clear by just a bit of searching that there are many, many gaps in the MGP database. The publication of the *Biographical Encyclopedia of Astronomers* (BEA), with the second electronic edition now online and the second print version due soon) provides us with about 1700 entries that can act as a first pass at names along with birth and death places and dates. However, one would not expect to be able to reconstruct genealogies for more than a handful of astronomers who worked before the 16th century. Another limitation is that the first edition of the BEA includes only astronomers born before 1918. Given the dictum that more scientists are alive today than in all of history before them, we will have a very significant number of additions to make to the database beyond the BEA list. We clearly need to enlist the interest of working astronomers to provide their own—presumably accurate—information to the database. For deceased astronomers who were missed by the BEA and other scientific biographical dictionaries, we do have a few useful sources. We have a solid series of obituaries,

unfortunately going back only to 1991, in the *Bulletin of the American Astronomical Society*. Other obituaries have appeared in national society publications and in journals. These can be easily searched with the NASA ADS or the Web of Science.

The scope of the Canadian portion of AstroGen is much more tractable. This is in part due to the sheer weight of the University of Toronto's contribution to reproduction and the limited number of institutions offering specifically astronomical training. The most significant fraction of working astronomers are members of CASCA and can be identified easily. ★

## Endnotes

- 1 This paper was written in early December 2013. Tragically, the author died on the 28th of that month before he could complete it. (For an obituary, see <http://cstha-ahstc.ca/tag/richard-adrian-jarrell/>.) Final editing and the writing of the abstract have been done by the Director of the AstroGen project, Joseph S. Tenn. Prof. Tenn is actively seeking additional members for the AstroGen team and welcomes correspondence ([joe.tenn@sonoma.edu](mailto:joe.tenn@sonoma.edu)).
- 2 Actually, Dupuis, who taught Mitchell mathematics when the latter was an undergraduate at Queen's, would be listed as Mitchell's mentor, not his supervisor. Mitchell later earned his Ph.D. at Johns Hopkins University under Charles Lane Poor—JST.
- 3 Nearly all who have earned Ph.D.'s in astronomy at Canadian universities have now been entered into the AstroGen database, thanks to the work of Peter Broughton and myself—JST.



# SkyShed POD MAX

Now completing development  
and launching shortly!

- Rugged construction (Built like a tank) 5.5" thick walls
- 6' 4" high wall with 32" wide door and a deadbolt lock
- Most affordable medium-sized dome ever
- Easy to assemble
- Multi configurations with POD MAX Bays and Dome only option
- Manual control to remote control
- Electronics by Kendrick Astro Instruments

- Designed for astro photography, education, and research
- Perfect for schools, clubs, and individuals with large scopes
- Ships to your door
- Pricing depends on model and level of automation. Please contact us for pricing.
- 12.5' dome with traditional slot design, 44" wide opening
- 20 degrees past zenith view



**Made in Canada for  
world wide export**

For more information please visit:

**[www.skyshedpodmax.com](http://www.skyshedpodmax.com)**

# Avoiding Battery Brownout: Tips for Astronomers

Peter D. Hiscocks

Syscomp Electronic Design Limited

Email: phiscock@ee.ryerson.ca

## Introduction

In the last two decades, amateur astronomy has been revolutionized by modern developments in electronics: digital cameras, image processing, and the GOTO telescope mount. It's now possible to click on some astronomical target on a laptop screen, or choose a target from a menu, and cause the telescope to slew to that location.



Figure 1 — iOptron Mini-Tower GOTO mount

The GOTO mount consists of motors, gears, and shaft encoders that are controlled by a microprocessor. In the field, the mount is powered by a portable battery, usually a 12-volt rechargeable battery.

The battery must be large enough to operate the mount—and any other equipment, such as dew heaters—for the duration of the viewing session. On the other hand, a battery is large and heavy so it should be no larger than necessary.

In this paper, we describe techniques for choosing a battery of appropriate size and then how to maintain and monitor the battery operation.

## Battery Theory

An electrical battery is a device for storing energy by some sort of chemical reaction. The plates of a lead-acid battery obtain a covering of lead sulphate during discharge, which changes back to lead during recharging.

In a lithium-ion battery, lithium migrates between the two plates of the battery.

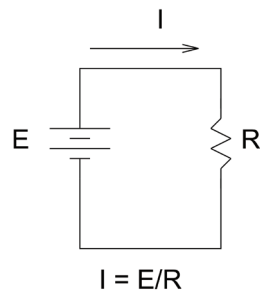

We can model a battery as an electrical device, without regard to the details of the battery chemistry. In Figure 2,  $E$  is the battery and  $R$  the load resistance. To a first approximation, the battery voltage remains constant as it

supplies current ( $I$ ) to the load resistance. Eventually the stored charge in the battery is depleted and the battery voltage drops.

Figure 2 — Modelling a Battery

## Battery Types

There are two main categories of batteries: *primary* (non-rechargeable) cells and *secondary* (rechargeable) cells. Here we shall concern ourselves with the latter.

Wikipedia (Web site 1) lists 21 different types of rechargeable cells. A small subset of those is in active, practical use. We list those, and one speculative unit—the *sugar* battery, in Table 1.

Type	Cell Voltage	Energy Density	E/\$ WH/\$	Self Discharge	SDA	Notes
Lead-Acid	2.1	35	6.5	4%/month	750	VRLA, AGM, Gel
NiCad	1.2	50	13	0.3%/month	1500	
NiMH	1.2	65	36	15%/month	750	
Li-Ion	3.6	200	29	7%/month	800	
Sugar	0.3 to 0.6	2000				Future

Table 1 — Battery Types

## Lead-Acid

The lead-acid battery is historically the oldest type of battery, but it continues to be popular. As shown in the table, it has the lowest energy density, indicating that it will have the largest size (and, as it turns out, largest weight) of these batteries. Also, as indicated in the table, it has the highest cost per watt-hour of energy stored. Not shown in the table, however, is the fact that the lead-acid battery is relatively simple to charge and maintain, and so it continues to be the first choice for this application. Much infrastructure exists for this type

of battery—for example, the battery *tender*, a device to charge and maintain a lead-acid battery—is readily available at reasonable cost.

## NiCad

NiCad batteries were popular at one time because they are capable of substantial short-circuit current; however, cadmium is very toxic so the battery creates a disposal problem, and it is now banned in the European Union.

## Nickel Metal-Hydrate (NiMH)

These batteries are a replacement for NiCad, especially for small, rechargeable batteries. NiMH batteries self-discharge about 15 percent after charging and then about 15 percent per month (2,3).

## Lithium-Ion

Lithium-ion batteries are a *substantial* advance in battery technology, with a huge increase of energy for a given size and decrease in weight compared to lead-acid batteries. Li-Ion has been an enabling technology for battery-operated power tools and electric cars, among others. However, Li-Ion requires a special charger, as overcharging will damage the cells and can cause an explosion. Catastrophic fires caused by microscopic short circuit between plates are a concern and require stringent quality control, sending up the cost. Generally speaking, the battery and its charger should be purchased together, ensuring that they are properly matched. Notice, also that the cell voltage is 3.6V compared to lead-acid's 2.1V, so Li-Ion is not a direct substitute for lead acid.

Li-Ion batteries will eventually show up as power for GOTO telescope mounts, integrated into the mount with the charging electronics. Celestron have just announced the NexStar Evolution 8, which has an integral Li-Ion battery. The mount is claimed to be capable of 10 hours of operation.<sup>1</sup>

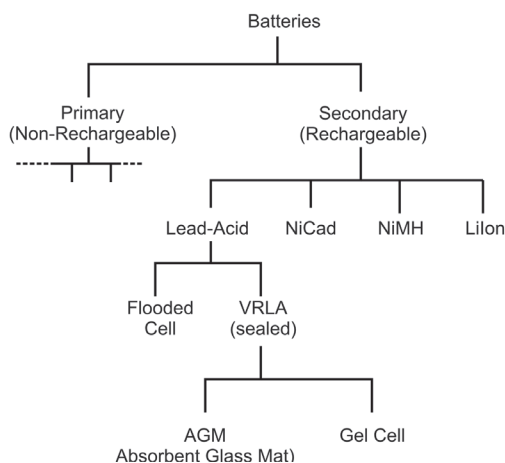

Figure 3 — Battery Types

## Types of Lead-Acid Battery

Drilling farther down in the battery hierarchy of Figure 3, there are three variations on the lead-acid battery.

### Flooded Cell

This is the historic design of lead-acid batteries where the plates are submerged in a liquid electrolyte. Each cell is in a separate compartment, with a removable cap. The battery produces oxygen and hydrogen gases when it is being charged, so it must be operated in a ventilated location. The battery must be maintained in an upright position and periodically refilled with distilled water. Flooded batteries cannot be shipped by air.

The state of charge of the battery can be determined with a *battery hydrometer*. A sample of the liquid electrolyte is sucked into a turkey-baster-like syringe. The level of a float in the syringe shows the state of charge of the battery.

According to Web reference 4, flooded batteries are the best choice for renewable-energy systems (such as a solar- or wind-powered system).

### Sealed Lead-Acid Battery

The generic term for a sealed lead-acid battery is *valve regulated lead-acid: VRLA*. These further subdivide into *absorbent glass mat (AGM)* and *gel cell*.

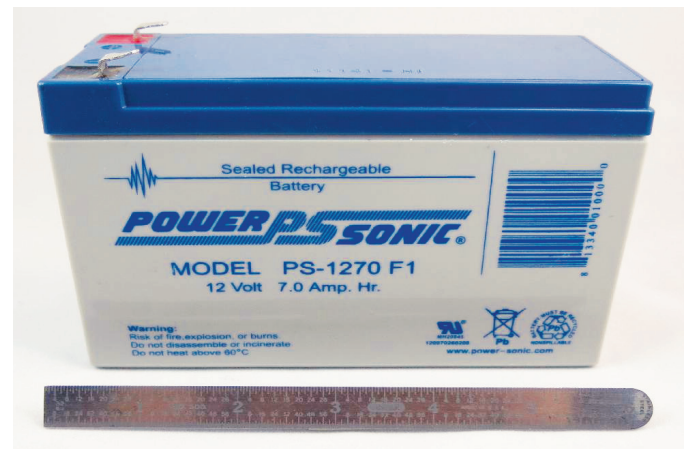

Figure 4 — Sealed Lead-Acid Battery

### Absorbent Glass Mat: AGM

AGM batteries have replaced flooded cells in automotive use, so they are readily available at reasonable cost. The battery is sealed and the electrolyte contained in a fibreglass matrix, so it does not vent gases when charged. The capacity and maximum output current are slightly less than a flooded-cell battery.



## Gel Cell

In a gel cell battery, the electrolyte is contained in silica gelatinous material. They are somewhat more acceptable in certain environments such as aircraft equipment; however, they are more expensive than an equivalent AGM battery, have higher internal resistance (limiting the maximum output current), and the capacity decreases at low temperature<sup>2</sup>.

The most common battery in use by amateur astronomers for their GOTO telescope mount is a lead-acid cell, VRLA (sealed), AGM type.

## Care and Feeding of the Lead-Acid Battery

### Charging

With some care, a lead-acid battery will last through 200 to 300 charge-discharge cycles over a period of years (5).

The ideal lead-acid cell charger charges the battery in three stages:

1. **Bulk Charge:** Charge the battery with constant current. The battery voltage increases as the battery charges. The rate of charging can be quite high as long as the charger transitions properly to the next stage (constant voltage) (6). The battery is about 70 percent efficient in converting charge current into stored charge, so more charge must be supplied than is actually stored.
2. **Topping Charge:** Hold the charging voltage at something between 2.3 and 2.4 volts per cell (13.8 to 14.4V for a 6-cell battery) until the charging current drops to a low value.
3. **Float:** Reduce the voltage to the *float* voltage and hold it there. The float voltage is 2.2 volts per cell, or 13.4 volts for a 6-cell battery at 26 °C. This voltage is critical and should be temperature compensated at a rate of  $-3.9 \text{ mV}/^\circ\text{C}$ .

### A Custom Charger

For those who are interested in the internal circuitry of a battery charger, there are many descriptions on the Web of constant-current constant-voltage supplies that can execute steps 1 and 2 of the charging protocol. However, it is rare to find a circuit that executes step 3, maintaining the float voltage.

The UC3906 integrated circuit, described in (8) and (9), is specifically designed to implement a battery tender, and probably a good place to start a custom charger design.



Figure 5 — Battery Tender

A charger that maintains a float charge can be left connected to the charger for long periods of time. The charger is then referred to as a battery tender (Figure 5).

A simple charger can be used to replenish the charge in the battery, but it then needs to be disconnected when the battery is fully charged. Failure to do that will damage the battery. Human beings tend to be distracted from watching over a battery, so simple chargers are usually a bad idea.

When purchasing a charger, look for the term *battery tender* and/or *temperature compensated float voltage*.

### Discharging

It is clear that one should not discharge the battery below its cutoff voltage. The value of the *cutoff voltage* varies from 12.5 to 10.5 volts among battery manufacturers and according to output current and duration of the discharge. Kendrick suggests 11.7 volts as a routine matter and certainly never below 11.0 volts (7). A higher value limits the capacity of the battery and a lower one endangers it.

It is especially important that the battery not be left in the discharged state, which will lead to sulphation of the plates and will destroy the battery. The battery will often recover from an excessive discharge if it is charged immediately.

### Battery Capacity

The *capacity* of the battery is given the letter C and is measured in amp-hours, that is, the product of the battery current and the time it can supply it<sup>3</sup>. For example, a 7-amp-hour battery should be able to supply 7 amps for one hour, or one amp for 7 hours, or 3.5 amps for 2 hours, and so on. This equation is very approximate: it depends on the history of the battery, the point at which the battery is deemed to be empty, the rate of discharge, and the ambient temperature. Consequently *the only way to be sure of battery capacity is to measure it*.

Battery charge and discharge currents are often given in terms of the battery capacity. For example, a 7-amp-hour battery being discharged at 0.1C is supplying a current of 0.7 amps.

## Measuring Battery Capacity

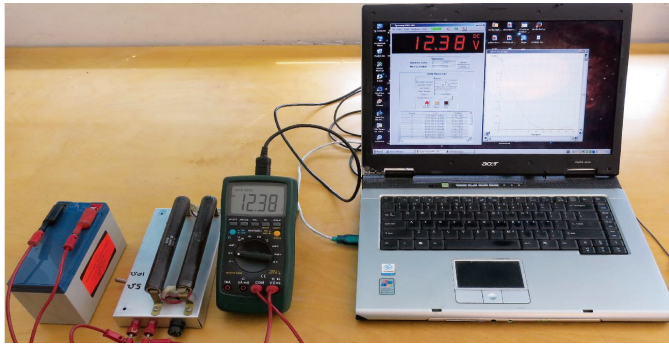

Figure 6a — Measuring Battery Capacity - Setup

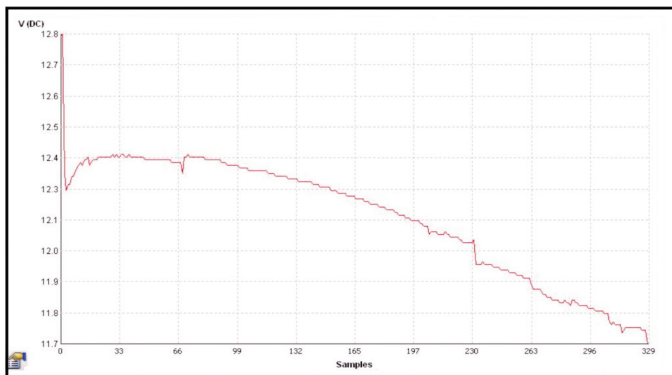

Figure 6b — Measuring Battery Capacity - Test Result

The load resistor must be chosen so that it is capable of dissipating the load power. For a 12-volt battery with a 10-ohm load, the power in the resistor is given by:

$$P = V^2/R_l = 12^2/10 = 14.4 \text{ watts}$$

The Ohmite L100J resistor is capable of dissipating 100 watts, so there is lots of safety margin with that resistor. It does, however, get quite warm, so it is best to mount it in the open, where air convection can occur.

To measure battery capacity, the battery is discharged through a resistor, as shown in Figure 6a. The battery voltage is recorded over time. When the battery reaches minimum allowable voltage (11.7 in the case of a lead-acid battery), the test is stopped. The capacity is calculated from the recorded graph.

The measurement setup is shown in Figure 6a. A 12-volt, 7-amp-hour battery<sup>4</sup> (blue) is connected to a 10-ohm, 100-watt load resistor<sup>5</sup>, the brown cylinders in the middle. The 10-ohm load gives an approximate load current of

$$I = \frac{E}{R} = \frac{12}{10} \text{ amps}$$

This load current isn't terribly critical, but it should be in the ballpark of the load current that will be used in practice.

A recording digital voltmeter Syscomp DVM-101<sup>6</sup> monitors the battery voltage while communicating the measurements to a laptop. The laptop computer records and displays a graph of the voltage against time. The resultant recording of battery voltage versus time is shown in Figure 6b. The measurements are taking place every 30 seconds, so reading 329 corresponds to 2.74 hours.

There are various ways to obtain the capacity from the graph. Very approximately, the average output voltage during the test interval was

$$V_{av} = \frac{V_{max} + V_{min}}{2} = \frac{12.4 + 11.7}{2} = 12.05 \text{ Volts}$$

Then the average current was:

$$I_{av} = \frac{V_{av}}{R} = \frac{12.05}{10} = 1.205 \text{ amps}$$

The time interval was 2.74 hours, so the battery capacity is:

$$C = I_{av} \times T = 1.205 \times 2.74 = 3.3 \text{ amp-hours}$$

For example, if the telescope mount draws 0.5 amps when operating, then the operating time would be about 6.6 hours. Notice that the measured capacity is only 47 percent of the battery nameplate capacity.

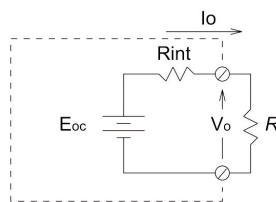

$$V_o = E_{oc} - I_o R_{int}$$

(a) Equation

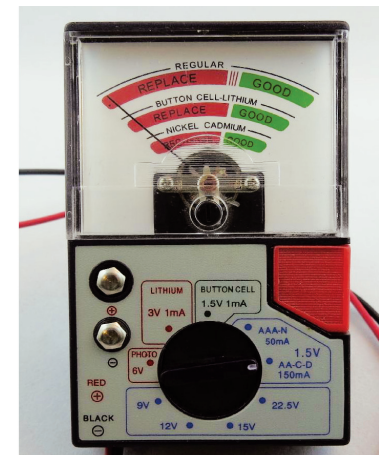

(b) Tester

Figure 7 — Internal Resistance

## Internal Resistance

When the battery is open-circuited, there is no output current, and the terminal voltage is called  $E_{oc}$  for *voltage, open circuit*. When current flows out of the same battery, the terminal voltage decreases. We model that effect by an *internal resistance*

in series with the output, as shown in Figure 7(a).

For example, suppose the open-circuit voltage  $E_{OC}$  is 12.4 volts, the internal resistance  $R_{int}$  is 0.04 ohms and the output current  $I_o$  is 1.5 amperes. Then output voltage is given by:

$$V_o = E_{oc} - I_o R_{int} = 12.4 - 1.5 \times 0.04 = 12.34 \text{ volts}$$

This internal resistance is representative of a healthy battery (11), so the output voltage is not much different than the open-circuit voltage; however, as the battery discharges or deteriorates, the internal resistance increases. The internal resistance is an important indicator of the state of the battery, so a proper test of battery condition should be done with a load attached. The open-circuit voltage, by itself, can be very misleading.

The tester for small batteries<sup>7</sup> of Figure 7b shows battery voltage under an appropriate load. This is much more useful than simply measuring the open-circuit voltage.

The internal resistance of a lead-acid battery is very low, so a substantial output current is required to indicate the state of the internal resistance. Furthermore, if the battery is connected to a short circuit, the output current is limited almost entirely by the internal resistance. For our example of a 12.4-volt battery with 0.04-ohm internal resistance, the short-circuit current is theoretically 310 amps! In practice, the internal resistance of the battery will increase under these conditions, but there can still be a very large short-circuit condition. For this reason, lead-acid batteries should have a fuse in the circuit.

It's useful to monitor the battery voltage under actual load conditions. If the battery voltage decreases significantly when supplying current, then the internal resistance may be a problem.

## Deep-Cycle (Marine) Batteries

These batteries are generally large and heavy, comparable in size and weight to an automotive battery. An automotive battery is constructed to have low internal resistance and consequently have large *cranking amperes* available for starting a car engine. To accomplish this, the plates are relatively thin. In use, a car battery is usually only partially discharged when starting the car engine. The car's charging system supplies the necessary current for the automotive accessories.

A deep-cycle battery is constructed to be charged and discharged over a larger range. To accomplish this, the plates are thicker than those in a car battery. The *cranking amperes* are lower, but the number of charge/discharge cycles to battery failure is higher. A deep-cycle battery is appropriate for applications such as electric vehicles.

How does this apply to powering telescopes and laptop

computers?

- If you need a large, heavy battery to operate your system, a deep-cycle battery is a better choice than a standard car battery. The deep-cycle battery can be repeatedly recharged and is likely to last longer.
- Smaller AGM and gel cell batteries are generally designed for repetitive charge/discharge cycles, so there is no advantage to deep-cycle batteries in smaller sizes.
- A deep-cycle battery should not be discharged any further than any other lead-acid battery: in the order of 11.7 volts (11).

## The Effect of Temperature

Lower temperature reduces battery performance in two respects: the battery capacity is lower (meaning it will discharge sooner for the same load), and the internal resistance is higher (meaning the output voltage will decrease more when a load is connected.) The internal resistance of a healthy lead-acid battery is extremely low, however, so it's mainly the battery capacity that is affected.

Battery capacity falls by about 1 percent per degree below about 20 °C. (12). For example, at -20 °C, the capacity of the battery is 60 percent of its value at 20 °C. Very approximately, the internal resistance will increase by 50 percent as the temperature drops from +20 °C to -20 °C (13).

Blake Nancarrow of the Toronto Centre of the RASC has a suggestion for cold-weather operation of a battery: place the battery in a food cooler<sup>8</sup>, optionally adding a chemical hand-warmer.

## Avoiding Battery Brownout: Summary

1. Choose a battery with enough capacity for the total current multiplied by the running time. Be conservative and use a safety factor of 2.
2. Charge and maintain the battery using a lead-acid *battery tender*.
3. Avoid discharging the battery below 11.7 volts.
4. Recharge the battery immediately after use. Do not allow it to sit in the discharged condition.
5. Periodically load test the battery to check its capacity.
6. Monitor the battery voltage during operation, using a digital voltmeter or expanded scale voltmeter.
7. Watch for the drop in voltage under load that signals increased internal resistance.

## Appendix: Expanded Scale Voltmeter

A digital voltmeter is an excellent instrument for monitoring the state of a battery, but it's not the most convenient device to

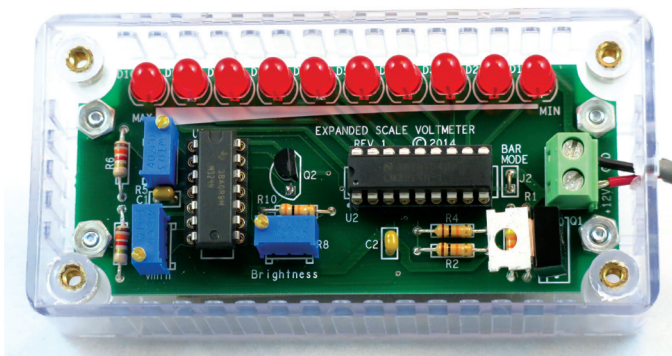

Figure 8 — Expanded Voltmeter Circuit Board

use in the dark. Some digital voltmeters have a backlight, but it drains the meter battery rather quickly. Furthermore, the battery-voltage changes under a transient load are not easy to view on a digital readout.

One possible alternative is the *expanded scale voltmeter* shown in Figure 8. The schematic is in Figure 9. This is a thermometer-type display of battery voltage on a special voltmeter scale expanded to show the range of voltages of interest. The readout is a row of LEDs, which are easy to view and interpret in the dark.

The design is based on the LM3914 Dot-Bar display integrated circuit (14), and one single-supply quad operational amplifier LM324. On the schematic of Figure 9, the range is shown as 11.0 V to 12.8 V. The upper and lower limits are adjusted independently by two potentiometers. The LED intensity is adjusted by a third potentiometer.

The display can be configured by means of a jumper to show a thermometer-type bar, or as a single moving dot. For monitoring the voltage supply of a telescope, red LEDs are most suitable since these do not affect night vision; however, other LED colours could be used instead.

## Adjustment and Calibration

You will need a voltmeter for this calibration.

- You can operate the expanded scale voltmeter circuit from any source of 12 volts, such as a 12-volt battery. The exact voltage is not critical. Connect the circuit to the power source, with extreme care to make sure the polarity is correct. The circuit is not diode protected and will be destroyed by a reversed-power connection.
- Check the reference voltage, at pin 7 of the LM3914. It should be 1.25 V.
- Check that pin 9 of the LM3914 is at +12 V, in order to select Bar display mode. If it's not at +12 V, check that the

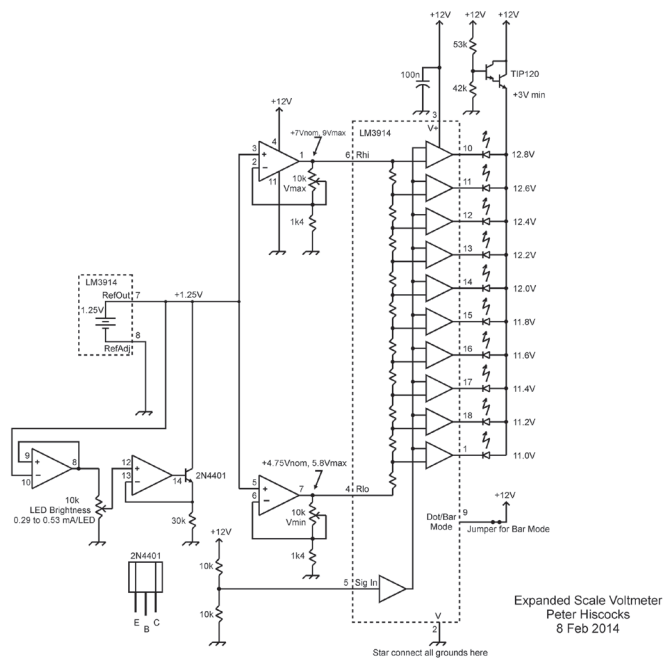

Figure 9 — Expanded Scale Voltmeter

jumper J2 is shorted together.

- Adjust the Intensity potentiometer R8 so that it is at maximum, *i.e.* pin 12 of the LM324 is at 1.25 V.
- Adjust the Maximum potentiometer R5 so that pin 6 of the LM3914 is at half the maximum indicated voltage. For example, if the maximum indicated voltage is 12.8 V, pin 6 should be at 6.4 V.
- Adjust the Minimum potentiometer R7 so that pin 4 of the LM3914 is at half the minimum indicated voltage. For example, if the minimum displayed voltage is 11 V, pin 6 should be at 5.5 V.
- If you have access to an adjustable voltage supply, connect the expanded voltmeter to that. Vary the voltage between minimum and maximum (11 to 12.8 V, for example) and the LEDs should display a column with no LEDs illuminated below 11 V and all LEDs ON above 12.8 V.
- Adjust the Intensity potentiometer R8 to give the desired LED brightness.
- In particular, watch for a drop in voltage whenever the telescope mount is slewing—and therefore drawing significant current from the battery. A significant drop indicates an increase in internal resistance, which suggests the battery needs charging or replacement. ★

## References

Hall, R.J. & Hiscocks, P. (1990). *A Microcomputer-Based Camera*

Quantity	Reference	Description	Value	Manufacturer	Part Number
2	C1, C2	CAP CER 0.1UF 50V 10% RADIAL	100n	Vishay	K104K15X7RF5TL2
10	D1..D10	LED SS 5MM 625NM RED DIFF	Red	Kingbright	WP7113LID
1	J1	CONN TERM BLOCK 2POS 5.08MM PCB	Terminal Block	Phoenix Contact	1729128
1	J2	SIL VERTICAL PC TAIL PIN HEADER	JUMPER	Harwin Inc	M20-9990245
1	Q1	TRANS NPN DARL 60V 5A TO-220	TIP120	Fairchild	TIP120
1	Q2	IC TRANS NPN SS GP 600MA TO-92	2N4401	Fairchild	2N4401BU
1	R1	RES 51K OHM 1/4W 5% AXIAL	51k	Yageo	CFR-25JB-52-51K
2	R2, R4	RES 10K OHM 1/4W 5% AXIAL	10k	Yageo	CFR-25JB-52-10K
1	R3	RES 43K OHM 1/4W 5% AXIAL	43k	Yageo	CFR-25JB-52-43K
3	R5, R7, R8	TRIMMER 10K OHM, 25T	10K	Bourns	3296W-1-103LF
1	R6	RES 1.6K OHM 1/4W 5% AXIAL	1k6	Yageo	CFR-25JB-52-1K6
1	R9	RES 2.7K OHM 1/4W 5% AXIAL	2k7	Yageo	CFR-25JB-52-2K7
1	R10	RES 30K OHM 1/4W 5% AXIAL	30k	Yageo	CFR-25JB-52-30K
1	U1	IC OPAMP GP 1.2MHZ 14DIP	LM324	Texas Instrument	LM324N
1	U2	IC DRIVER DOT BAR DISPLAY 18-DIP	LM3914	Texas Instrument	LM3914N-1/NOPB
1	n/a	IC Socket 18 DIP		Assmann WSW	AR18-HZL-TT-R
1	n/a	IC Socket 14 DIP		Assmann WSW	AR14-HZL-TT-R
1	n/a	IC Socket 14 DIP		Hammond	1591ATCL

Table 2 – Parts List

Control System. *Photogrammetric Engineering and Remote Sensing*, 56, No. 5, (April 1990), 443-446.

## Endnotes

- 1 Thanks to Dave Roberts for a pointer to this product.
- 2 The author once constructed a 28-volt, gel cell battery pack to operate a helicopter-borne instrumentation system with a capacity of 40 amp-hours. The battery pack was massive: 39 kg. A VRLA battery pack would have been smaller and lighter, but was not permitted by regulation (Hall & Hiscocks 1990).
- 3 The amp-second is a measurement of electrical *charge*, 1 coulomb (electrons), so an amp-hour is equal to 3600 coulombs.
- 4 PowerSonic PS-1270 F1.
- 5 Ohmite L100J10R, available from Digikey, \$10.
- 6 [www.syscompdesign.com](http://www.syscompdesign.com), \$79.
- 7 Canadian Tire #52-0057-2, \$10.
- 8 For example, Canadian Tire #85-3469-6

## Web sites

- 1 Rechargeable battery: [http://en.wikipedia.org/wiki/Rechargeable\\_battery](http://en.wikipedia.org/wiki/Rechargeable_battery)
- 2 Nickel-metal hydride battery: [http://en.wikipedia.org/wiki/Nickel-metal\\_h\\_battery](http://en.wikipedia.org/wiki/Nickel-metal_h_battery)
- 3 Elevating Self-Discharge: [http://batteryuniversity.com/learn/article/elevating\\_self\\_discharge](http://batteryuniversity.com/learn/article/elevating_self_discharge)

- 4 Deep-Cycle Flooded Lead-Acid Batteries (FLA): [www.trojanbatteryre.com/Tech\\_Support/ComparingFlood-2VRLA.html](http://www.trojanbatteryre.com/Tech_Support/ComparingFlood-2VRLA.html)
- 5 Can the Lead-acid Battery Compete in Modern Times? [http://batteryuniversity.com/learn/article/can\\_the\\_lead\\_acid\\_battery\\_compete\\_in\\_modern\\_times](http://batteryuniversity.com/learn/article/can_the_lead_acid_battery_compete_in_modern_times)
- 6 Sealed Lead-Acid Battery Charging Basics: [www.powerstream.com/SLA.htm](http://www.powerstream.com/SLA.htm)
- 7 Power Pack FAQ, Kendrick Astro Instruments: [www.kendrickastro.com/powerpackfaq.html](http://www.kendrickastro.com/powerpackfaq.html)
- 8 Improved Charging Methods for Lead-Acid Batteries using the UC3906; Unitorde Application Note U-104: [www.ti.com/lit/an/slua115/slua115.pdf](http://www.ti.com/lit/an/slua115/slua115.pdf)
- 9 O'Connor, John A. *Simple Switchmode Lead-Acid Battery Charger*. Unitorde Application Note U-131. Available at: [www.ti.com/lit/an/slua055/slua055.pdf](http://www.ti.com/lit/an/slua055/slua055.pdf)
- 10 Powerstream: Internal Resistance: [www.powerstream.com/1922/battery\\_1922\\_WITTE/batteryfiles/chapter08.htm](http://www.powerstream.com/1922/battery_1922_WITTE/batteryfiles/chapter08.htm)
- 11 What happens to the voltage of a deep-cycle battery during use? [www.knowyourplanet.org/off-grid/batteries/deep-cycle-battery-voltage-and-discharge](http://www.knowyourplanet.org/off-grid/batteries/deep-cycle-battery-voltage-and-discharge)
- 12 Photovoltaic Education Network: <http://pvcrom.pveducation.org/BATTERY/charlead.htm>
- 13 Battery Performance Characteristics: Electropaedia: [www.mpoweruk.com/performance.htm](http://www.mpoweruk.com/performance.htm)

# Thomas Digges's Perception of Stellar Sizes and Distances

Peter D. Usher

Department of Astronomy and Astrophysics

The Pennsylvania State University

University Park PA 16802

pxu1@psu.edu

## 1. Introduction

After 1543, when Copernicus (1473–1543) published his theory of a heliocentric Universe contained within a sphere of stars, the apparent angular sizes of stars became a sticking point, because contemporary data and theory indicated that star sizes would be implausibly large (Danielson and Graney). This misperception of stellar sizes arose because observers believed that what they saw with the naked eye was a true image of the sizes of stars. Observers did not know that stellar images are effectively point sources because they are so far away, and that atmospheric turbulence and other phenomena grossly enlarge their images.

## 2. Question

In his 1576 essay, Thomas Digges (c.1546–1595) postulates the existence of stars at indeterminately large distances (an “infinite” Universe) and refers to the sizes of stars as “far excellence our sonne...in...qualitye.” The question arises whether Digges’ statement is consistent with the suggestion that he studied the stars telescopically (Ronan, Usher). Support for this position comes *inter alia* from the work of Gainer (*op. cit.*), who has constructed and applied a telescope of a design prescribed in 1571 in the book *Pantometria* by Thomas and his father Leonard Digges (c.1521–1571?). This design is essentially a proto-Herschelian, and is *not* the so-called Digges-Bourne design usually considered to be the Diggesian telescope (Ronan, Whittaker).

## 3. Stellar distances

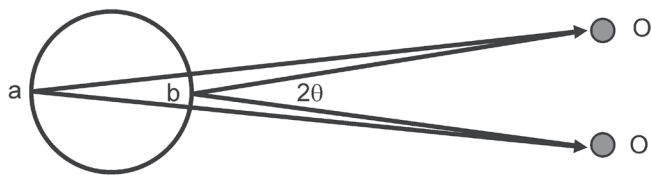

Figure 1 — In a bounded Universe, two stars “O” lying on the Firmament (the supposed eighth sphere of the stars) appear farther apart when the Earth is closer (angle ObO) than when it is more distant (angle OaO).

To address the question of stellar sizes and distances in Digges’s model, consider first the bounded Sun-centred Universe that Copernicus imagined. Stellar distances can be determined in principle by the method of parallax. If the Earth were to orbit the Sun (as from “a” to “b” to “a” in Figure 1), the angular separation between two stars situated near the ecliptic (*i.e.* in the plane of the Earth’s orbit) and separated by an angle  $\theta$  as seen from the Sun ( $\frac{1}{2}$  of the sum of angles OaO and ObO in the idealized geometry of Figure 1), should change depending on how close the observer is to them. If  $d$  is the distance to the stars and  $2a$  is the diameter of the Earth’s orbit, the relative change in  $\theta$  is given by:

$$(1) \quad \frac{\Delta\theta}{\theta} \approx \frac{2a}{d}, \quad (d \gg a),$$

where the diameter in Equation (1) results from points “a” and “b” being diametrically opposite. Shifts about the size given by Equation (1) would have been discernible, but the fact that none were detected led Copernicus to the conclusion that stars had to be very distant. However, like Ptolemy (AD 90–168), he opted for a bounding sphere of stars, and left “to the philosophers” to decide the question of the finitude of the Universe (Copernicus 17).

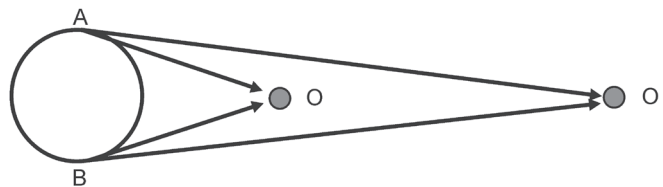

Figure 2 — If stars are distributed through space and if circle AB represents the Earth’s orbit around the Sun, an observer moving between A and B will detect a larger angle AOB when star O is closer. By convention, one-half of angle AOB is the parallax angle  $p$ .

Whereas, when stars are scattered through space as Digges proposed, as the two depicted in Figure 2, the annual parallax angle  $p$  is one-half the angle AOB, given by:

$$(2) \quad p = \frac{a}{d}, \quad (d \gg a),$$

where  $p$  is measured in radians (1 radian = 206265 seconds of arc  $\approx 57.3^\circ$ ). The closer the star, the smaller  $d$  and the larger is the parallax angle  $p$ .

Tycho Brahe (1546–1601), who was born three years after Copernicus’s theory was published, opposed the model,

*Continued on page 205*

# Pen & Pixel



Figure 1 — Jack Newton provides us with this spectacular image of the eta Carina Nebula, one of the Southern Hemisphere's astronomical gems. The nebula contains two large OB (hot, blue) stellar associations that help to power the nebular emission, which covers an area more than four times the size of the Orion Nebula complex. Eta Carinae itself is a luminous hypergiant star with a luminosity more than 4 million times that of the Sun.



Figure 2 — Winnipeg's Ron Berard used the Canada Day long weekend to take 99 15-second exposures of the old barn, fireflies, and a visiting dog, with a Nikon D90 and a Sigma 14-mm lens at f1.2. Ron then selected the 20 best to assemble this image. Ron states, "With the fireflies, I thought naming the photo "Sparky" would be appropriate." The scene is lit by the Moon and by several frames illuminated by flashlights and a strobe inside and outside the barn. After the images were assembled, a foreground mask was pasted over the star trails. Ron states, "I like the converging colours and time inferences; the "spark" of fleeting, short-lived fireflies, an old farm dog that strayed into the yard, older barn and equipment, and seemingly ageless sky captured as the world turns."

Figure 3 — Klaus Brasch captured this wide-area image of M16 (right) and a little-photographed companion emission nebula, Sharpless 2-54 (the Nested-Egg Nebula), both in Serpens Cauda, using a TMB-92 refractor, a Canon 6D at ISO 6400, and an IDAS LPS-V4 filter. The image is a stack of two 3-minute exposures from the dark skies near Flagstaff, Arizona.

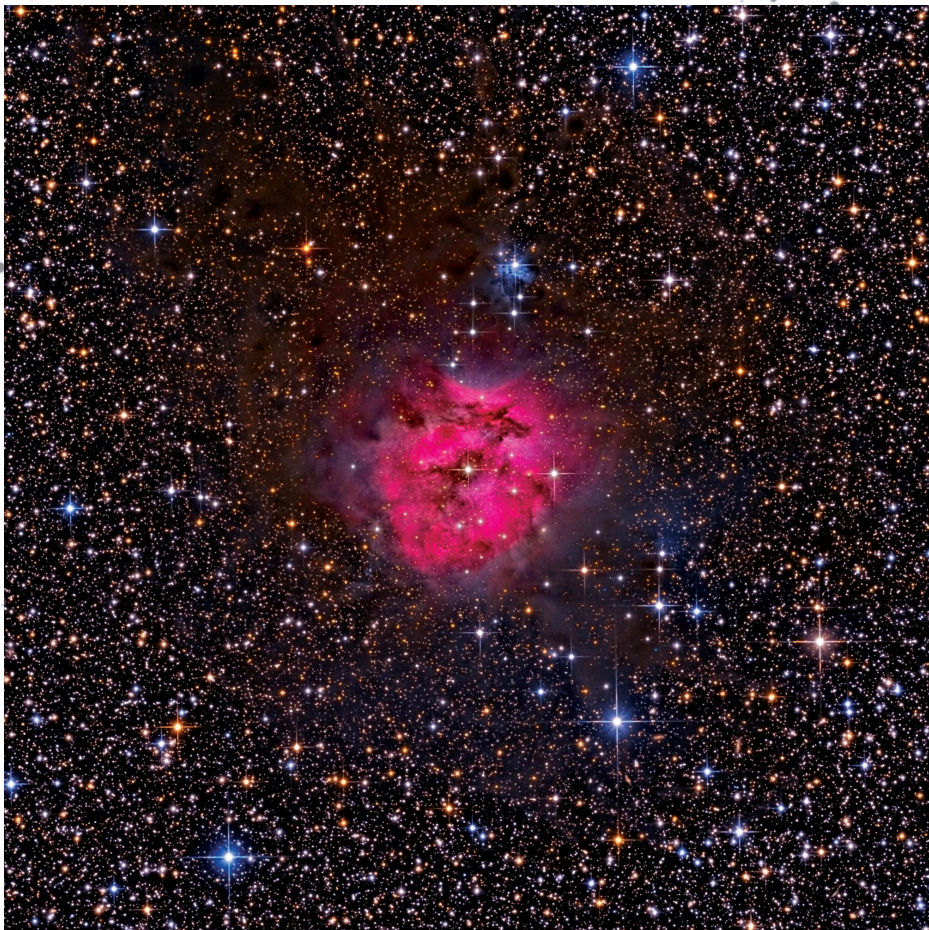

Figure 4 — Ten hours of exposure produced this deep-sky image of the Cocoon Nebula (IC 5146) in Cygnus, a complex area of both reflection and emission nebulae, jewelled with the stars of a small open cluster. Above the Cocoon lies a small reflection nebula illuminated by a hot B-type star. Howard Trottier obtained the frames for this image from his “Cabin in the Sky” Observatory in the Okanagan using a PlaneWave CDK17 telescope and an Apogee U16M camera. Integration time was divided about equally between unbinned Luminance and 2x2 binned RGB exposures. Howard describes the image fancifully as “a leaf floating along a silted stream, with the stars that crowd the corners giving the impression of multicoloured gems deposited there by the current.”





*Figure 5 — Mark Burnell travelled to Mink Lake in Manitoba's Nopiming Provincial Park in late July to find skies dark enough to show off the Milky Way. In mid-summer and fall, the Milky Way galaxy stands straight up from the horizon, displaying its best parts to determined observers. Mark used a Canon 5D2 with an f/4 17-mm lens on an iOptron tracker to acquire the eight 89-sec exposures assembled into this photo. The meteor was a bonus.*

*Figure 6 — Cassiopeia glows in unusually intense colours in reflection in this image from Lynn Hilborn. Lynn used a modified Canon 6D at ISO 1600 with a 24-mm lens at f/3.5 and a 25-second exposure.*



*Figure 7 — Sheila Wiwchar is both the girl in the red dress and the photographer in this Manitoba composition of stars, Moon, and clouds. Sheila's photography goes beyond the usual star scenes, as she believes that a photo of the night sky is incomplete unless it has one or more persons in it.*



*Figure 8 — The Iris Nebula is a bright reflection nebula in Cepheus illuminated by its embedded open cluster NGC 7023. Winnipeg's Jay Anderson used a TMB 130-mm refractor, a Canon 60Da camera, and 105 minutes of exposure to capture this image.*

Continued from page 200

and one of his calculations is illustrative. On assuming that heliocentricism is the case, and after taking into account the errors of his instruments, Tycho concluded that, seen from a star distant  $d$ , the Earth's orbital radius  $a$  subtends an angle  $p$ , given by Equation (2), no greater than  $30''$  (51; unattributed references are to van Helden). Tycho's upper limit of  $30''$  was well short of a detection of a stellar parallax, the first of which was measured by Friedrich Wilhelm Bessel (1784-1846) in 1838-9, who found a value  $p$  of about  $\frac{1}{3}''$  for the star 61 Cygni (Berry 361).

The upper limit of  $30''$  that Tycho found, equals 0.00015 radians; *i.e.*  $p < 0.00015$  radians (51, 74). Equation (2) gives  $d = \frac{a}{p}$ , so  $d$  had to be greater than  $0.00015^{-1}$  (= 6900) times  $a$ . Tycho believed that  $a$  was 1150 Earth radii ( $E_r$ ), which was smaller but not too different from values in other geocentric cosmologies (and about 5 percent of the modern value). Thus,  $d$  had to exceed 7.9 million  $E_r$ , or about 700 times the then-accepted distance of Saturn. Since the volume of a sphere increases as the cube of its radius, he thought that the volume of space surrounding the Solar System would have to exceed that occupied by his model by a factor of 700 cubed, or over 300 million times (Thoren 279). Not only did Tycho and other detractors of Copernicanism think it impossible for the ponderous Earth to move, but also they believed that such a huge empty space between the planets and the stars was absurd, as it served no purpose.

Tycho thought that he had shown heliocentricism to be wrong, but instead he had placed a lower limit on size of the Copernican *immensum*. He failed to see that he had made a great advance, because he believed his result was at odds with prevailing Aristotelian teleology, which proclaimed the functionality of everything in the plenum.

#### 4. Stellar radii

Geocentricists thought, furthermore, that the great distances of the stars implied by their lack of parallax also disproved heliocentricism in another way. If  $s$  is the radius of a star, then its angular radius seen from Earth would be

$$(3) \quad \sigma = \frac{s}{d}.$$

Pre-telescopic observers thought they were seeing the actual angular sizes,  $\sigma$ , of the stars. As a result, Tycho thought that stars visible to the naked eye had apparent angular radii  $\sigma$  lying in the range of 1 to  $1/6$  minutes of arc, or 0.00029 to 0.000048 radians, so that if  $d$  were 7.9 million  $E_r$ , then stars had to have radii of 400 to 2300  $E_r$ . This range was far in excess of the 5  $E_r$  that the Sun's radius was thought to be. Geocentricists made the implicit assumption that stars were like the Sun and should be about the same size, but since

stars had to be exceptionally large in order for their grossly overvalued relative sizes to accommodate heliocentricism, they concluded that the Earth does not orbit the Sun. Instead, they argued, since geocentric models placed stars at distances in the range of 19,000 to 20,100  $E_r$  (or 14,000  $E_r$  in Tycho's geo-heliocentric model) (27, 30, 32, 50), star radii had to be about 5.8  $E_r$  at most, *i.e.* about the then-known size of the Sun (or in Tycho's model, somewhat smaller than the Sun). Thus, the implicit assumption that star images were true measures of angular size was consistent with bounded geocentric models of the Universe, which therefore continued to attract adherents.

#### 5. Telescopy

Nevertheless, rumblings of dissent began after 1610 when Galileo Galilei (1564-1642) assembled his telescope. He found that it magnified the images of planets by amounts proportional to their apparent angular sizes, whereas the same could not be said of the stars, whose images were magnified far less than might be expected. Observers must have had reservations about their assumptions and the nature of stars because reports of their apparent diameters then became increasingly rare (71-2).

MWT Associates, Inc.

The smart choice for science and astronomy tours.

Atacama Large Millimeter/sub-millimeter Array (ALMA)

MWT Associates, Inc. offers innovative astronomical travels to exotic destinations in search of eclipses, meteor showers, and northern lights. Whether you are looking for the latest in astronomical events and places or historical astronomy itineraries, our dedicated staff and team of distinguished experts can take you there in signature style as your compass to a new discovery.

[www.melitatrips.com](http://www.melitatrips.com)

1 (408) 279-5589

1-877-707-7827

Inspiring the Stargazer In You



Figure 3 — The unbounded heliocentric model of Thomas Digges (from *A Perfit Description* 1576).

Galileo noticed too that stellar and planetary images appear much smaller during twilight than at night, when the contrast between the brightness of the sky and star is highest, signifying that star sizes in vogue were too large. Johannes Kepler (1571–1630) reached the same conclusion after 1611, once he had assembled a telescope using two convex lenses. Despite personal limitations in constructing and using telescopes, Kepler noticed that ever-improving optical quality failed to reveal any resolvable disk, and as a result, he and others started to think of star sizes as indeterminate and smaller than commonly believed (89, 103, 181n56).

## 6. *A Perfit Description*

In 1572, a “New Star” (the supernova SN1572) burst forth in the Firmament and was studied by Tycho Brahe and Thomas Digges, among others. Johnson and Larkey (113) posit that sometime in the course of observing SN1572, Digges “pointed one of his telescopes towards the heavens,” and McLean (150) asserts that: “Digges’s conviction of ‘stars innumerable’ indicates some kind of optical penetration of space.” The question of this paper is what effect a potential telescopic study of the heavens would have on Digges’s notions of stellar distances and sizes.

As argued above, the invention of the telescope led to decreased apparent angular sizes of stars’s  $\sigma$ , which increased the probability of detecting parallax; and by Equation (2), for relatively stable values of  $a$ , the continued failure to detect

parallax with improving telescopic resolution meant that the Universe of stars had to become larger and larger. Those who believed, through use of the telescope, that neither  $p$  nor  $\sigma$  could be measured, had to accept that the distances and sizes of stars were indeterminate. Let us examine these developments in light of Digges’s writing.

In 1576, Thomas Digges wrote an essay entitled *A Perfit Description of the Caelestiall Orbes according to the most aunciente doctrine of the Pythagoreans, lately revived by Copernicus and by Geometricall Demonstrations approved* in which he proposed that the heliocentric, planetary system was imbedded in a sea of stars distributed throughout space. Digges’s illustration is seen in Figure 3, in which the annotation reads:

*This orbe of starres fixed infinitely up extendeth it self in altitude sphericallye and therefore immovable the pallace of foelicitye garnished with perpetuall shinginge glorious lightes innumerable far excellinge our sonne both in quantitye and qualitye the very court of coelestiall angelles devoyd of greefe and replenished with perfite endlesse joye the habitacle for the elect.*

If Digges studied the stars telescopically, he would have seen stars in ever-increasing numbers as a function of their apparent brightness no matter what telescope aperture he used. For a given threshold, starting with the naked eye, stars would appear as if scattered across the “orbe” of the sky, so that an inductive argument would lead him to assert the existence of an infinite distribution:

*Of whiche lightes Celestiall it is to bee thoughte that we onely behoulde sutch as are in the inferioure partes of the same Orbe, and as they are hygher, so seeme they of lesse and lesser quantity, even tyll our sighte beinge not able farder to reach or conceyve, the greatest part rest by reason of their wonderfull distance unto us.*

This means that observers behold that part of the “Orbe of starres fixed infinitely up” that lies “in the inferioure partes of the same Orbe,” *i.e.* closer to the observer. This is because the farther away the stars are (“as they are hygher”), so they seem fainter and fainter until observers see none at all (“of lesse and lesser quantity, even tyll our sighte beinge not able farder to reach or conceyve”). As a result, the rest of the stars are invisible owing to their distance (“not able farder to reach... the greatest part rest by reason of their wonderfull distance unto us”). With a great inductive leap, Digges asserted that the process would continue to an unknown bound (“infinitely up”), where according to the *Oxford English Dictionary*, from about 1385, “infinite” could have a “loose or hyperbolic” meaning for quantities indefinitely and exceedingly great.

Digges asserted moreover that the “orbe” of stars is immobile (“and therefore immovable”), because if an infinite distribution were to turn, its inconceivably distant extremity would

have an incredibly large speed. Digges had enunciated the existence of what we know today as an inertial standard of rest, and the perceived motion of the sky relative to the Sun and the horizon is then explained by the Copernican hypothesis to which Digges in his essay fully subscribed.

By use of telescopes, Thomas Digges may have reached the same conclusion that Kepler reached in the early 17th century, that stars remained unresolved no matter the quality of telescopic images, so that actual angular star sizes were immeasurably small. Like Galileo, who as van Helden has stated was “a supremely talented observer [and] could make fairly accurate measurements of angular diameters” (71), Digges would have been able to estimate the apparent angular sizes  $\sigma$  of the stars telescopically. He would also have been able to decrease the observed limit of parallax  $p$ , and so would be led to the idea of an infinite starry plenum, yet in the annotation in Figure 3, he chooses to enunciate the pre-telescopic view of stellar sizes (“glorious lightes innumerable far excellinge our sonne both in quantitye and qualitye”). How shall this be explained?

## 7. Conclusion

“Infinite space” was a hotly debated topic in the 16th century, and Digges’s advocacy, couched in reverent terms (“the very court of coelestiall angelles devoyd of greefe and replenished with perfite endlesse joye the habitacle for the elect”), would not have been too upsetting to theologians, as the concept was already extant. In particular, on theological grounds, Nicholas of Cusa (1401–1464) disputed the Ptolemaic model and asserted that the Earth did not rest at the centre of the Universe, because an infinite Universe has no centre (Dijksterhuis 227).

The issue of telescoping was a different matter, however, because telescopes had obvious military uses. As early as about 1267, Roger Bacon wrote in *Opus majus* that by arranging two lenses, “a small army might appear very large,” and in addition, “the sun, moon, and stars in appearance ... descend here below.” In 1578, in *Inuentions or Deuices. Very necessary for all generalls and captaines, or leaders of men, as wel as by sea as by land*, William Bourne (1535–1585) describes the Digges-Bourne telescope design (see section 2). Despite the subtitle to his work (“necessary for all generalls and captaines...by sea as by land”), Bourne declines to elaborate on military applications (“you shall see a small thing [at] a great distance...this is very necessary...as the viewing of an army...which I doo omit”).

At the time, the nascent Protestant state of England was menaced by Catholic countries on the Continent that wished to restore England to the Catholic fold, and Mary Stuart, Queen of Scots, the Catholic claimant to the throne of England, had not yet been beheaded. It would benefit national

security if the telescope and its military capabilities were kept out of the limelight. I suggest that around 1576–1578, by simply repeating conventional wisdom on the sizes of stars rather than entering into the unresolved problem of stellar distances and sizes, Digges would not attract attention to the new-fangled optical device and to its application in warfare. By downplaying its potential in studying the stars, Digges would also avoid exacerbating religious tension between England and her neighbours, because he would keep secret his inquiry into the sacrosanct heavens and the abode of the gods. ✱

## References

- Berry, Arthur (1961). *A Short History of Astronomy* (1898). New York: Dover.
- Copernicus, Nicolaus (1995). *On the Revolutions of the Heavenly Spheres* (1543). Trans. Charles Glenn Wallis. New York: Prometheus.
- Danielson, Dennis & Graney, Christopher M. (2014). “The case against Copernicus.” *Scientific American* 310, 72–77.
- Dicks, David R. (1970). *Early Greek Astronomy to Aristotle*. New York: Cornell University Press.
- Dijksterhuis, E.J. (1986). *The Mechanization of the World Picture* (1961). Princeton: Princeton University Press.
- Gainer, Michael K. (2009). Construction of a 16th-century telescope: An experiment in the history of astronomy. *Journal of the Royal Astronomical Society of Canada* 103, 18–21.
- Johnson, Francis R. & Larkey, Sanford V. (1934). Thomas Digges, the Copernican System, and the Idea of the Infinity of the Universe in 1576. *The Huntington Library Bulletin* V, 69–117.
- McLean, Antonia (1972). *Humanism and the Rise of Science in Tudor England*. New York: Neale Watson Academic Publishers.
- Ronan, Colin A. (1991). “The origins of the reflecting telescope.” *Journal of the British Astronomical Association*, 101, 335–342.
- Thoren, Victor E. (1990). *The Lord of Uraniborg*. Cambridge: Cambridge University Press.
- Usher, Peter D. (2010). *Shakespeare and the Dawn of Modern Science*. Amherst, NY: Cambria Press.
- van Helden, Albert (1985). *Measuring the Universe: Cosmic Dimensions from Aristarchus to Halley*. Chicago: University of Chicago Press.
- Whittaker, Ewen A. (1993). The Digges-Bourne telescope—an alternative possibility. *Journal of the British Astronomical Association* 103, 310–312.

*The Royal Astronomical Society of Canada is dedicated to the advancement of astronomy and its related sciences; the Journal espouses the scientific method, and supports dissemination of information, discoveries, and theories based on that well-tested method.*

# Orbital Oddities: Trying for the Tetrad

by Bruce McCurdy, Edmonton Centre  
(bmccurdy@shaw.ca)

At a Lunar Eclipse

Thy shadow, Earth, from Pole to Central Sea,  
Now steals along upon the Moon's meek shine  
In even monochrome and curving line  
Of imperturbable serenity.

– Thomas Hardy, *At A Lunar Eclipse*

What a pleasant surprise it was to see the word “tetrad” work its way into the popular lexicon earlier this year, when a semi-rare sequence of four successive total lunar eclipses at intervals of six lunations (lunar months) got underway. Less so was the connection made in many of those articles between the so-called “Blood Moons” of 2014–2015 falling on a sequence of religious holidays, especially in light of recent events. Such interpretations are well beyond the scope of this *Journal*, but tetrads themselves are a legitimate and fascinating astronomical phenomenon, one that we explored in detail in this column about a decade ago (McCurdy 2003, 2004). One of the more fascinating aspects is the distribution of tetrads, which occur in very long “seasons” lasting some three centuries, followed by a similar period where they are impossible (Figure 1). The current century is in the middle of one of those high seasons, and will feature eight tetrads, of which 2014–2015 is the second such set, following that of 2003–04.

As with many eclipse phenomena both solar and lunar, the interval between tetrads is invariably one of the famous eclipse cycles, either Saros ( $S = 223$  lunations = 6585.32 days = 18 years +10 or 11 days), Inex ( $I = 358$  lunations = 29 years –20 days), or some combination of the two. In the current instance, the interval since the last tetrad has been:

$$I - S = 135 \text{ lunations} = 11 \text{ years} - 31 \text{ days,}$$

a period also known as the Tritos. Note the similarity in calendar dates of the two series, with the –31 days component pushing the whole sequence forward by about one calendar month:

2003–04: May 16, Nov. 09, May 04, Oct. 28

2014–15: Apr. 15, Oct. 08, Apr. 04, Sep. 28

One of the intriguing aspects of the current tetrad is that all four totalities are theoretically visible from my location in Edmonton, Alberta, and indeed from throughout the western half of North America (Figure 2). I wondered how unusual this set of circumstances could be?

Tetrads per century, 900-2799

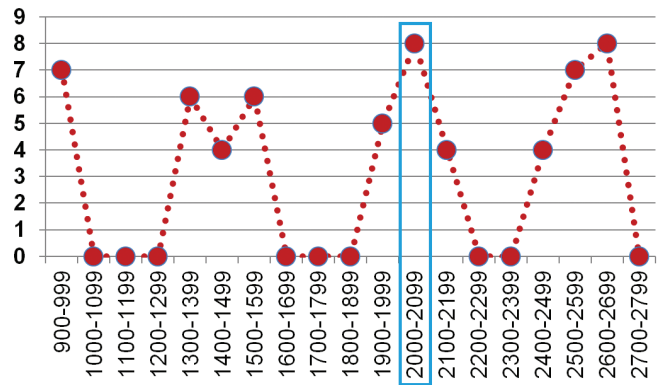

Figure 1 — Tetrads of four consecutive lunar eclipses follow a cycle some six centuries in length, coming in and out of season like a long-period tide. Currently, tetrads are “in season” with the 21st century particularly rich with eight tetrads. Figure derived from Meeus (2004).

Leaving aside atmospheric refraction, the visibility zone is half the Earth (the night side) for the instant of mid-eclipse. Taking into account our planet’s rotation during the event, slightly less than half of the planet is situated to see all of totality, slightly more than half to see any part of totality.

To calculate the probability of seeing all four eclipses from a given location, the simplest, back-of-the-envelope form is to set the threshold event as mid-totality, making the observability of each event essentially a coin flip for that location. For four in a row, that raw probability is reduced to  $2^{-4} = 1/16$ . So, not that rare, but the tetrads themselves are sparse enough that one is fortunate to get one such set in a lifetime.

Because they occur at six-lunation intervals, one would expect there to be two eclipses on either side of the celestial equator (or in the case of this and most tetrads when in mid-season, all four events fairly close to the equinoxes), so terrestrial latitude should not be much of a factor in terms of probabilities for the set of eclipses other than at polar latitudes. But, terrestrial longitude would be the more critical factor.

A proxy for longitude is simply the time of greatest eclipse. In the current instance, we have the following sequence (all times UT):

2014 Apr. 15, 07:46

2014 Oct. 08, 10:55

2015 Apr. 04, 12:00

2015 Sep. 28, 02:47

One way to consider the problem is to calculate what I’ll call the “clock span” that would encompass all four events. In this case, all occur between 02:47 and 12:00, a span of 9 hours and 13 minutes. This falls nicely in the middle range of what might be considered theoretically possible if the times were truly random: a minimum span of 0 h 00 m (all eclipses at the same

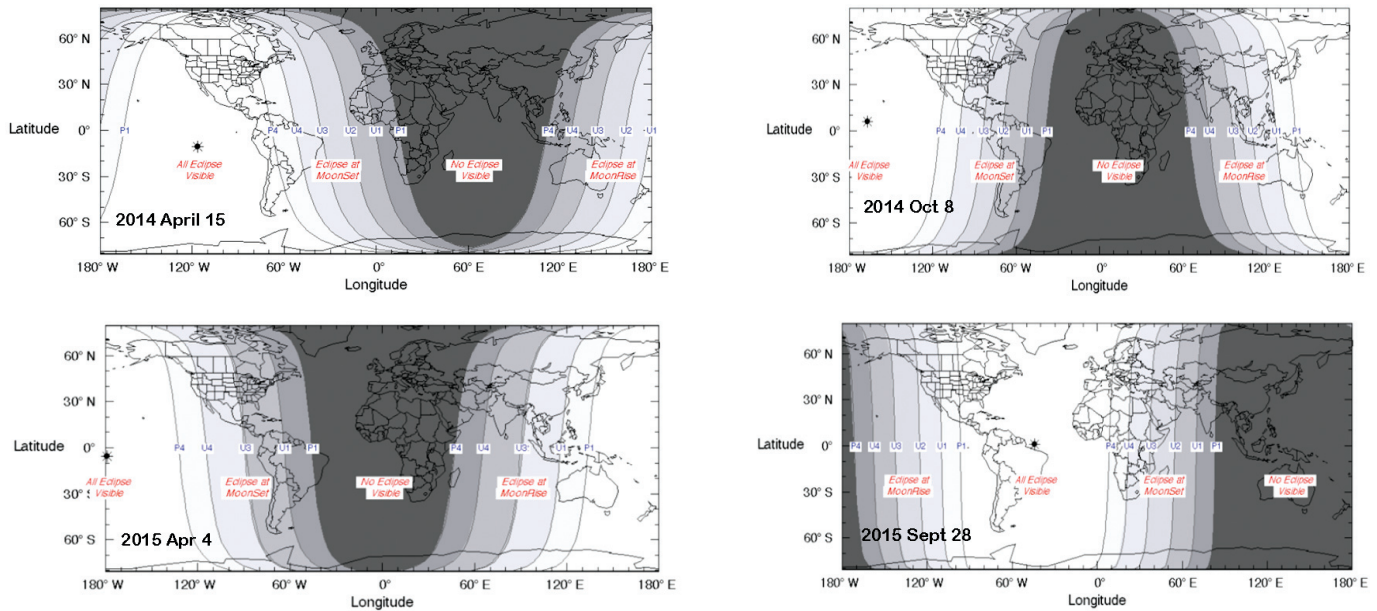

Figure 2 — Visibility zones of the four members of the tetrad of 2014-2015. Mid-eclipse for all four events happens to occur in the Western Hemisphere, meaning observers in North America, particularly its western extent, are favoured. Figures courtesy Fred Espenak of NASA Eclipse Web site & RASC Observer's Handbook.

time) and a maximum of 18 h 00 m (eclipse times perfectly spread out at 6-hour intervals). In reality, neither extreme is possible; the three-body problem is neither random nor regular. While the average lunation has a precise value (one synodic month = 29.530589 days), the actual interval from one full Moon to the next can range over more than 13 hours due to the elliptical nature of both Earth's and the Moon's orbits. Furthermore, the "long" and "short" lunations bunch together (Meeus, 1991; also McCurdy, 2001). While one might expect a semester of a shade over 177 days ( $6 \times 29.5$ ), in the current tetrad the interval between the first two eclipses is 176 days, 3 hours; between the second and third, 178 days, 1 hour. Much depends on the initial position of the Moon with respect to its perigee at the beginning of the tetrad.

That said, consecutive tetrads at an interval of one Saros feature very similar initial conditions for all three bodies, as all the important periods: synodic, anomalistic, and draconic months, plus calendar years, can be closely approximated by integers. Thus the characteristics of these tetrads have things in common. For instance, check these four tetrads, each featuring members of Saros #121-126-131-136:

Tetrads Interval 1 Saros	Intervals between eclipses 177d +/- X hrs.	Clock span
1949-1950	-1, +18, -17	7:33
1967-1968	-2, +19, -17	7:19
1985-1986	-2, +19, -18	7:14
2003-2004	-3, +20, -18	7:10

The intervals between consecutive members of a given tetrad are expressed in hours over or under 177, and in each case, the sequence follows a very similar pattern, as does the clock span. However, the Inex is much less useful here. It does *not* include anything approximating an integer number of anomalistic months, meaning the initial conditions of the Moon's distance from Earth are different.

Tetrads interval 1 Inex	Intervals between eclipses 177d +/- X hrs.	Clock span
1985-1986	-2, +19, -18	7:14
2014-2015	-21, +25, -9	9:13
2043-2044	+11, -6, +15	14:31
2072-2073	+1, +15, -13	10:20

Even though we do see recurrences of tetrads at the interval one Inex, the sequencing of eclipses and the clock span varies significantly from one family to the next.

For those tetrads with a clock span significantly less than 12 hours, it stands to reason that it should be possible somewhere in the world to have all four members of those groups visible. The shorter the span, the wider that area of visibility; matched, of course, by an area of *invisibility* on the opposite side of the globe.

And, so it is. RASC Honorary Member Jean Meeus is one of the world's leading experts in the field of eclipse prediction and further is a gracious gentleman who will respond to

Years of the tetrads	Visibility at Edmonton	Visibility at Uccle	Visibility in N. China
1909 – 1910	0 1 1 1	1 0 0 1	0 1 0 0
1927 – 1928	1 0 0 1	0 1 0 0	0 1 1 1
1949 – 1950	1 1 0 1	1 1 1 1	0 0 1 0
1967 – 1968	1 1 1 1	0 0 1 0	1 1 0 1
1985 – 1986	0 0 0 0	1 1 0 1	1 1 1 1
2003 – 2004	1 1 0 1	1 1 1 1	0 0 0 0
2014 – 2015	1 1 1 1	0 0 0 1	0 1 1 0
2032 – 2033	0 0 0 1	0 1 1 0	1 1 1 1
2043 – 2044	0 1 0 1	0 1 1 0	1 0 1 1
2050 – 2051	0 1 0 0	1 1 1 1	0 0 0 1
2061 – 2062	0 1 1 0	1 0 1 1	0 1 0 1
2072 – 2073	0 0 1 0	0 0 0 0	1 1 0 1
2090 – 2091	0 0 0 0	1 1 0 1	0 0 1 0

Figure 3 – Tetrad visibility table from three locations for the years 1900–2099, provided by RASC Honorary Member Jean Meeus, who comments: “The table gives the visibility of the lunar eclipses of the tetrads of the current series at Edmonton (113.5° W, 53.5°N), at Uccle, Belgium (4.4°E, 50.8°N) and at a place in NE China (125°E, 51°N). An eclipse is considered to be visible if, at maximum phase, the Moon is above the horizon. The following codes are used: 0 = not visible, 1 = visible. So, for instance, “0 1 1 1” means that the first eclipse of the tetrad is not visible, but the next three are visible. It appears that all four eclipses of the tetrad of the years 1967–1968 were visible at Edmonton, and this will again be the case for the tetrads of the years 2014–2015. On the contrary, the four eclipses of the tetrad of 1985–1986 were not visible from Edmonton, and this will again be the case for the tetrad of the years 2090–2091.”

any manner of bizarre queries about planetary phenomena. At my request, Jean provided a table (shown here as Figure 3) of mid-eclipse visibility for three locations separated by about 120° longitude: my home in Edmonton; his home in Uccles, Belgium; and a third location in northeast China.

The 120° corresponds to the “extra” third of a day in the Saros cycle of 6585.32 days. The theory being that the visibility sequence for a tetrad in one region would largely be repeated

in another, a third of a world away, 18 years later. The proof is in the pudding: all four tetrad members theoretically visible in Edmonton in 2014–2015, in China in 2032–2033, and in Belgium in 2050–51. A similar rotation of all eclipses visible in one spot occurred four times over from 1949–1950 to 2003–2004, with Uccle having been favoured twice over, in both the first and last sets.

Bottom line is that it’s not so uncommon for an observer at a single location to have an opportunity to observe all four members of a tetrad, as I hope to do in 2014–2015. Indeed, it’s not impossible for someone to have this chance twice in a lifetime, as I might have had I lived in Edmonton in 1967–1968, or as someone living in Western Europe may have experienced in 1949–1950 and 2003–2004.

Now that we’ve worked *that* out, what is the likelihood the “weather gods” will favour us four times out of four? ★

*Bruce McCurdy joined RASC one Inex period ago, in 1985. He has observed well over a dozen total lunar eclipses—including, through broken cloud, the first member of the current tetrad—mostly from the public observatory at Telus World of Science Edmonton where he has volunteered for 28 years. He hopes to observe all four members of the ongoing quartet from that same location.*

## References

- Espenak, F. 2013–14, *RASC Observer’s Handbook 2014*, D. Chapman, Ed., 127, 132, & OH 2015, 130, 134
- McCurdy, B. 2003, *JRASC*, 97, 234
- McCurdy, B. 2004, *JRASC*, 98, 202
- McCurdy, B. 2001, *JRASC*, 95, 39
- Meeus, J. 2004, *Mathematical Astronomy Morsels III*, (Willmann-Bell Inc.: Richmond), 123
- Meeus, J. 1991, *Astronomical Algorithms* (Willmann-Bell Inc.: Richmond), 354

WWW

RASC Internet Resources

 Like us on facebook

 Follow us on Twitter @rasc

[www.rasc.ca](http://www.rasc.ca)  
Visit the RASC Web site

[www.rasc.ca/discussion](http://www.rasc.ca/discussion)  
Email Discussion Groups

[www.rasc.ca/contact](http://www.rasc.ca/contact)  
Contact the Society Office

[www.rasc.ca/news](http://www.rasc.ca/news)  
RASC eNews



# Perception and Reflection: The Earliest Image of Sunspots?

R.A. Rosenfeld, RASC Archivist  
(rosenfel@chass.utoronto.ca)

## Abstract

What may be the earliest image of a sunspot observation is discussed. In our day, it has featured in extending the time series of secular solar evolution, although its original reasons for creation were doubtless different. This paper examines some of the difficulties in dealing with observational material of potential value but stemming from an observational tradition distant from our own.

## Lost in translation

It is common in popular histories of astronomy to encounter theories, instruments, and images presented as hugely significant for their role in altering the production of knowledge. Images may then appear and reappear in latter accounts as signally important or representative, acquiring an “iconic” status, such as Claude Mellan’s lunar engravings, engravings of Herschel’s 40-foot reflector, or the Hertzsprung–Russell Diagram. The conferral of “iconic” status is frequently retrospective. Certain historical images, instruments, and theories are elevated to importance in self-constructed views of astronomical progress culminating in the present science, producing a history as comforting as it is temporally and culturally contingent. Previous dominant accounts of the progress and shape of astronomical disciplines can diverge significantly from ours. If a way were found to present post-17th-century accounts of the 17th-century discovery of the telescopic Sun to their discoverers, it is quite likely they would find our accounts of their work partly or wholly indigestible, incomprehensible, and impertinent. Handling 17th-century material as contemporaries would have done—or to our best informed approximation, and being sensitive to the diverse perspectives with which 17th-century observations were handled over time—can provide some relief from an unreflective presentism, and a constructively nuanced way forward. Of course, the earlier the material, the greater the act of translation necessary to render it scientifically intelligible today.

## The earliest sunspot drawing?

What is now often taken to be the earliest extant drawing of sunspots (Figure 1) is found in a 12th-century manuscript of a Latin chronicle from England attributed to John of Worcester (Stephenson & Willis 1999; Murdoch 1984, 257 [233]; Vaquero & Vázquez 2011, 73–74)<sup>1</sup>. The observation was taken 1128 December 8, and its accompanying text reads:

*In the 3rd year of the reign of Lothar, Emperor of the Romans, and the 28th year of the King of the English,*

*Henry, in the 2nd year of the 470th Olympiad, the 7th indiction, the 25th luration proceeding, the 6th day before the ides of December, on Saturday from morning till the time of vespers there appeared as it were two dark balls below the orbit of the Sun. One, which was the larger, in the upper part, and the other, which was smaller, in the lower part. Each was aligned against the other, as in this figure.*  
(Oxford, Corpus Christi College Library, MS 157, Chronicle of John of Worcester, ca. 1140, folio 380 recto).<sup>2</sup>

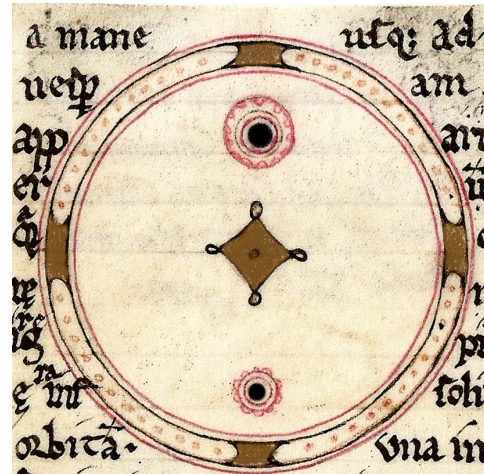

Figure 1 — John of Worcester’s illustration of the Sun and purported sunspots.

An observation from 1128 December 8. Copyright *Specula astronomica minima*/R.A. Rosenfeld.

The translation above is more disciplined than the “freer” translations that have appeared in the secondary literature, whose word choices appear to be influenced by an *a priori* desire to include the 12th-century observation within the sunspot canon. It may well be an authentic observation of a couple of “great” sunspots visible to the naked eye, but forcing a translation is the equivalent of arbitrarily weighting particular data. There is no need for it.

## Problems of language and clash of worldviews

John of Worcester’s account is difficult to interpret, because there appears to be no contemporary solar observational context into which it can be set; it is, for all intents and purposes, a one-off for its time. The language used in the text and the representational conventions in the drawing are hardly those of the present. Its alien nature from our standpoint is worth probing.

We would not describe sunspots as “two dark balls below the orbit of the Sun,” but our established technical vocabulary for solar surface features is not that of the 12th century. John had to use the descriptive materials of his time, within the context of his worldview, the cosmology and astronomy of which could be described as the Christian portion of transmitted Hellenism available to an English monastic chronicler between Bede and Richard of Wallingford, but who was no Bede or Richard of Wallingford. The Sun was placed in the realm of objects not subject to change and corruption. Spots could not mar the solar surface by occurring on it, but they could be sub-lunary objects in orbits beneath the Sun seen against its surface from the Earth. In that context, some medieval writers, according to the Ptolemaic (Aristotelian) order of the planets, interpreted

great sunspots as transits of Mercury and Venus across the Sun. John of Worcester's "two dark balls below the orbit of the Sun" clearly fit this context, although he mentions neither Mercury nor Venus by name.<sup>3</sup> If his "two dark balls below the orbit of the Sun" are two great sunspots fit into the descriptive paradigm of objects transiting below the Sun, he has made a similar error to Kepler's as reported in his *Astronomiae pars optica* of 1604!

Some data we would consider crucial is missing from John's account. Was he the original observer, or is he just reporting an observation made by someone else? If the latter case, did he receive the observation at second or third hand, and was it by word of mouth or through another (now lost) text, and was it accompanied by a drawing? Chroniclers often reported other people's data. And why was there a gap of perhaps 12 years between the observation and its recording in Corpus Christi MS 157? The last question can be answered by recourse to genre. To a certain extent, monastic chronicles were by their nature works of compilation, and the materials that would eventually be gathered in "final" or presentation texts (equivalent in some respects to our publications of record) would be entered in working notebooks (*schedulae*), in the margins of other unconnected works, or even on ephemeral media such as wax tablets. Such text supports may not survive.<sup>4</sup> The 1128 observation may have had a continuous textual existence for over a decade until it was entered in the present manuscript, but if the artifactual evidence hasn't survived, the proof for that is gone. For the purposes of this discussion, we will write as if the observation was made by John, but readers should be aware that that may not be the case. (A similar caveat should be issued for the drawing. John was probably the artist, and he will be referred to here as such, but there is always that possibility that another hand was responsible for that part of the work.)

## Drawing Spots

John's drawing consists of a circular diagram in line with the text, consisting of an outer circle in red, a second circle in light-brown enclosing four quadrants, each filled with small circles (12 to 13 per quadrant—some in the lower-right quadrant have red dots in their centres), enclosed on the inner side by another circle in light-brown. The quadrants are divided by cartouches with black borders, and filled with gold leaf. The cartouches are placed at the approximate 0°, 90°, 180°, and 270° position angles. The next circle is in red. Near the top of the interior field is the larger dark ball in black, surrounded by a thicker red circle, then a light-brown circle, then another red circle with fifteen arcs in red around the interior of its circumference. Near the bottom of the central field is the smaller dark ball in black aligned in the same vertical place as the larger dark ball, enclosed by a red circle, in turn enclosed in a thicker red circle with red arcs around the exterior of its circumference. In the centre of the diagram is a cartouche with a black border and empty finials at its four corners; it is filled with gold leaf. The central cartouche is in the same vertical plane as the dark balls.

The drawing was most likely made with a quill pen and compass. The black colour is probably a gallo-tannate ink, as is the light-brown pigment (but diluted). The red is probably minium (red lead). There are some signs of construction marks, and false runs of the compass and pen. The sequence in which the graphic elements were laid down can be read from the areas in which the overlapping of the media is visible (Rosenfeld 2014).

As he did with the language chosen to describe the phenomena, John had to use the graphic materials and conventions of his day to depict what he saw. His task as an artist, however, was much more difficult than his task as an author, for the simple reason that he had no direct models as far as we know—there were no earlier depictions of either great sunspots or transiting planets he could use. What was available for him to potentially adapt to his novel purpose was the rich tradition of illustration originating in the Carolingian world (possibly with late-antique antecedents) of iconographic programs for late-antique cosmological texts; Pliny the Elder's (fl. ca. AD 22-79) *Naturalis Historia*, Calcidius's (4th century AD) *Timaeus a Calcidio translatus commentarioque instructus*, Macrobius's (5th century AD) *Commentarium in Somnium Scipionis*, and Martianus Capella's (5th century AD) *De nuptiis Philologiae et Mercurii*.

These works contained various circular diagrams. An example from the Capellan tradition dating to the century before John has diagrams with features that could have inspired John's general approach (Florence, Biblioteca Medicea Laurenziana, MS Laur. San Marco 190, saec. XI in., folio 102 recto; Eastwood 2007, 332), had a similar manuscript been available to him. Circles, borders created by circles within circles, geometrical forms placed in the centre of a diagram, and circles aligned in the vertical plane can all be found in early eclipse diagrams (Eastwood & Grasshoff 2004, 127-131; Eastwood 2007, 332). If John believed he was observing transits of objects across the Sun, as other medieval observers did, then repurposing elements from eclipse diagrams would make good sense. Inventing an appropriate iconography from existing materials is not a mechanical process, and if John did so, he deserves credit for having the imagination and skill to envision an iconography forged from elements of an existing tradition. In our terms, John may have been an innovator.

Western medieval scientific illustrations worked differently from our observational drawings. It seemed literal, visual realism was neither the aim nor the intent. In modern terms, medieval scientific drawings are best thought of as analogous to our diagrams of optical ray tracings, spectrometer or photometer blueprints, or Keplerian orbital parameters. They are useful schemata to aid in the comprehension of a text.

## Perspective

In our day, John's diagram and text have been accepted as a record of a sunspot observation, and incorporated in extensions of the time series of secular solar evolution (Vaquero & Vázquez 2011). Those who have used it thus may indeed be

right to do so, but the full alterity of his report compared to more recent ones has to be acknowledged. Medieval chroniclers habitually noted unusual and noteworthy events; they did not habitually monitor solar activity. John's reasons for making his observation were unlikely to be modern scientific ones, the conceptual framework into which he fit his observation is not ours, and the textual idiom and graphic conventions at his disposal are not those of our time. And there is the matter of crucial lost data (whose observation is it?).

Beyond reconstructing the possible worldview—the context—in which a “scientific” illustration was originally created, cognizance must also be taken of the limitations of the technology used to capture the image. We do this regularly with images captured today (estimating and publishing signal-to-noise ratios, the parameters of algorithms used to process images, the spectral profiles of filters, *etc.*), and we should do it with earlier images where possible. Several authors have remarked of John's drawing that what is “remarkable in the sketch is the clear distinction between umbra and penumbra” (Vaquero & Vázquez 2011, 74). Is it reasonable to expect the naked eye to possess the necessary resolution to differentiate between umbral and penumbral areas of great sunspots? Are there any well-documented modern analogues of such observations? Is a decorative element in a 12th-century drawing being mistaken by 21st-century commentators for an observed feature? Over-interpretation can happen when we do not recognize the cultural differences separating our work from that of our predecessors.

John's image gave rise to no direct progeny, as far as we know. It would be nearly five centuries before a regular practice of making graphic records of solar observations started, and when it did, it was via the newly invented telescope (Figure 2). Many of those early 17th-century images seem immediately more modern, less alien, and inherently easier to comprehend and use today. Are they? Could an apparent familiarity be disarming us from asking contextually appropriate questions of the visual data?

We owe it to the integrity of earlier solar observations, as we owe it to the integrity of modern astrophysics, to try to fully comprehend what we are dealing with when we attempt to use earlier data. The joining of ancient data with modern is not hopeless, but we have to come to terms with what we can know, what we might know in a limited way, and what we'll never know.

## Acknowledgement

This research has made use of NASA's Astrophysics Data System. \*

## References

### Manuscripts, Books, and Articles

- Eastwood, B. S., & Grasshoff, G. (2004). Planetary Diagrams for Roman Astronomy in Medieval Europe, ca. 800-1500. *Transactions of the American Philosophical Society, New Series*, 94, 3, i-iii, v-xiv, 1-21, 23-71, 73-115, 117-147, 149-158.
- Eastwood, B. S. (2007). Ordering the Heavens: Roman Astronomy and Cosmology in the Carolingian Renaissance. *Medieval and Early Modern Science* 4, 117-120

*Blaris magna sumpta J.*

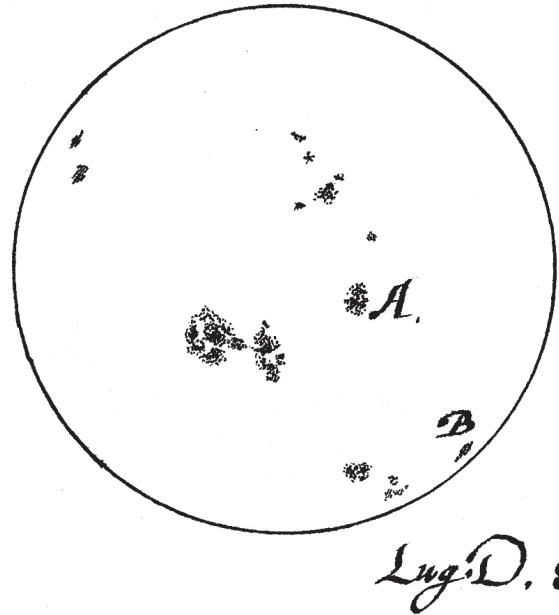

Figure 2 – Sunspot drawing after Galileo Galilei, 1612 July 8. Copyright *Specula astronomica minima*/R.A. Rosenfeld.

- Galilei, G. & Scheiner, C. (2010). Reeves, E. & van Helden, A. (Ed. and Trs.), *On Sunspots*. Chicago-London: University of Chicago Press.
- Lewis, S. (1987). *The Art of Matthew Paris in the Chronica Majora*. (California Studies in the History of Art 21). Berkeley: University of California Press.
- Murdoch, J. E. (1984). *Album of Science 3: Antiquity and the Middle Ages*. Cohen, I. B. (Ed.) New York: Charles Scribner's Sons.
- Rosenfeld, R. A. (2014). Reverse Engineering an Astronomical Image, *JRASC* 108, 2, 76-78.
- Stephenson, F. R. & Willis, D. M. (1999). The Earliest Drawing of Sunspots. *Astronomy and Astrophysics* 40, 6, 21-22.
- Vaquero, J. M. & Vázquez, M. (2011). The Sun Recorded Through History. *Astrophysics and Space Science Library* 361. Berlin: Springer
- Vaughn, Richard (1958). *Matthew Paris*. Cambridge: Cambridge University Press.
- Xu, Z., Pankenier, D., & Jiang, Y. (2000). *East-Asian Archaeoastronomy: Historical Records of Astronomical Observations of China, Japan and Korea*. Amsterdam-Abingdon: Gordon & Breach.

## Endnotes

- This is the first known sunspot *drawing*, not the first sunspot observation. They had been noted, chiefly by far-eastern observers much earlier, with the first reliably dated observation occurring in 165 BC; Xu *et al.* 2000; Vaquero & Vázquez 2009, 67-73. There were also a few earlier European observations; Galilei & Scheiner 2010, 10-16.
- “[25] [A]nno regni .iiio. Leodegarii romanorum Imperatoris. Regis uero [26] anglorum heinrici .xviii. Olimpiadis .ccce.LXXē. [27] anno. iio Indictione .viiio. luna .xxv. existente [28] VI. Idibus Decembris. Sabbato a mane usque aduesperam [29] apparauerunt quasi duę nigře pilę infra solis [30] orbitam. Vna insuperiori parte. et erat [31] maior. Altera Inin[-] [32] feriori. et fuit minor. [32] erat que vtraque [33] directa contra alteram [34] Ad huius modi figvram;” transcription and translation by the author. As several authors have observed, John did not get his dating clauses quite right; Stephenson & Willis 1999, 22.
- My interpretation of John's text disagrees with that offered by van Helden and Reeves in their fine *Galilei & Scheiner* 2010, 15.
- Some of those of the 13th-century monastic chronicler Matthew Paris do survive, and may give an idea of the basic materials John of Worcester used in the previous century. Matthew Paris was also a chronicler who could illustrate his own work; Vaughan 1958; Lewis 1987.

# John Percy's Universe

## Adventures in School Astronomy

by John R. Percy  
(john.percy@utoronto.ca)

What is the most effective way to ensure maximum public awareness and understanding of astronomy? I would argue that it is by ensuring that astronomy is included in the school curriculum and is that is relevant and well taught. (Percy, 2005).

Easier said than done.

In classical times, astronomy was one of the seven liberal arts, but it fell out of favour in U.S. schools (and probably, by extension, in Canada) when, in 1893, the influential Committee of Ten recommended “that Astronomy be not required for admission to college” (Bishop 1990). Thereafter, the place of astronomy in the school curriculum was tenuous at best. In this short article, I reflect on my own six decades of school astronomy.

If it was in the curriculum when I was in school in the 1950s, it didn't stick. It was there, in some form, during my brief career as a high school teacher in the 1960s (Percy 2012; Figure 1). It appeared in novel form at the end of that decade.

### Space and Man

*Space and Man* was introduced in Ontario in 1969 as an optional course at the senior level in high school. At the

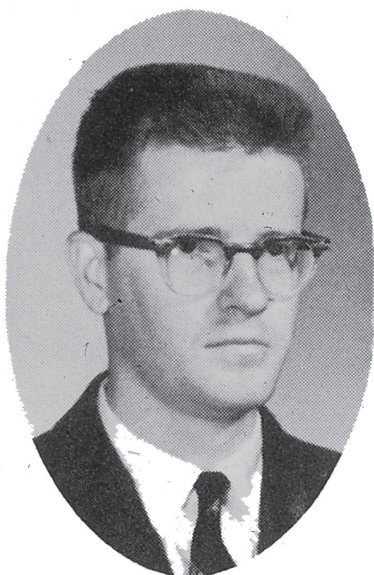

MR PERCY

Figure 1 — The author in 1964-1965, when he was “Mr. Percy,” a math and science teacher at Bloor Collegiate in Toronto.

time, there was a movement to a much more student-centred approach to education, both in schools and in universities. *Space and Man* was not a rigid curriculum but a list of possible topics that the class could choose to cover. In keeping with the times, the students were expected to have a voice in choosing the course content.

The high-water mark for education funding in Ontario was 1970. I was one of a group of “resource people” who were shipped to Ottawa (at the Ministry of Education's expense) to conduct a workshop on the course for teachers. It was here that I made the acquaintance of the noted science fiction writer and anthologist Judy Merrill.

### Creating Curriculum and Meeting Creationism

*Space and Man* survived for another decade or two, but the curriculum gradually swung back to a more centrist position. (The curriculum is now reviewed regularly every few years, sometimes in response to a change of government, or new theories/fads in education.) During the 1970s and 1980s, I was a consultant to a number of interesting resource books: MacBean *et al.* (1973), Paul *et al.* (1973), and Ewers and Ewers (1976). Paul *et al.* (1973) was a short book on *Motion in the Heavens*, part of a six-unit, grade-12 physics course *Physics: A Human Endeavour*. Doug Paul was a fellow graduate from the University of Toronto astronomy program, so the astronomy content in this book was impeccable. I even wrote my own *Teacher's Guide to Astronomy* with my daughter Carol, who is now a Professor of English at the University of Toronto (Percy and Percy 1986).

In the mid-1980s, we astronomers became aware of a major curriculum renewal in the province. We were too late to lobby for compulsory astronomy in the curriculum, but we did succeed in getting optional astronomy units into grade-10 science and grade-12 physics. The optional grade-10 astronomy unit gave me the wonderful experience of writing astronomy chapters for a top-notch, high-school science textbook, in this case, under the guidance of an outstanding educator, writer and editor—Bill Andrews (Andrews *et al.* 1988). This still remains one of my most enjoyable education experiences.

The optional grade-12 physics unit was a slightly different story. We had an excellent writing team. Astrophysics fit naturally with units on light, as well as atomic and nuclear physics. We submitted a draft of what we thought was an excellent unit, and were surprised when it came back from the Ministry of Education with several things removed—the origin of the chemical elements, the age of the Sun, and the evolution of stars. There was a closet creationist somewhere!

As it turned out, I was to give a paper at a joint meeting of the Canadian and American Astronomical Societies in Vancouver in 1987 on my experiences with school astronomy.

I mentioned the creationism incident, not knowing that there was a reporter for *Science News* in the front row. My experience was mentioned in that well-read magazine, and was picked up by *The Globe and Mail*—the one and only time that I have been on the front page of “Canada’s national newspaper.” I was then approached by the CBC to “debate” with a creationist, with a CBC person as a “neutral/unbiased moderator.” I declined, which may or may not have been a good decision. The problem with such so-called debates is that it then looks as if there are two points of view and, given the state of public science literacy, people then assume that both points of view are equally valid. I also became aware of local anti-creationist organizations that were even more rabid than the creationists themselves. Not that I have any problem with religion as such, even though I am not of any particular religious persuasion myself. There are many ways in which science and religion can and do co-exist, whether through separation, integration, dialogue, or mutual support (Barbour 2000).

## Two Astronomers Go to Court

In the 1990s, I served as Honorary President of the Science Teachers Association of Ontario<sup>1</sup>, including during their 1990 centennial year. STAO is one of my favourite organizations. Among many other things, it holds a large, annual, three-day conference, that includes dozens of useful workshops and other presentations. It also includes exhibits by providers of educational resources. One year, a creation science organization insisted on having an exhibit booth.

Normally, I would be very much in favour of free speech, but creation “science” is different. It picks, chooses, and bends scientific evidence to apparently “prove” (among other things) that the Universe is only a few thousand years old, using the exact antithesis of the scientific method. To most teachers, their “evidence” might sound convincing—or at least to merit equal time. As an active member of the STAO Board, I agreed that we should seek an injunction to permit us to decline the creationists’ application for an exhibit booth.

The problem is that there are very few lawyers with a background in astronomy, but we had one—the RASC’s own Michael Watson. He did his research; we both went to court (me for the first and last time, he appropriately attired), and we got our injunction. “Creation science” is still rampant, especially in the U.S., and we continue to do what we can to educate teachers about how scientists know that the Universe is old, and evolving<sup>2</sup>.

## Creating the Present Curriculum

In 1999, there was yet another major curriculum renewal. This time we were ready, and the Ministry of Education was supportive. They agreed to include compulsory units on astronomy and space in grade 6 and grade 9. There was also a grade-12 Earth and Space course, which is excellent, but not

offered in many schools. I was not involved in writing the draft curriculum; this was done by a mixed group of “stakeholders,” including parents. But, I got to do a serious review and revision of the final version and, other than the opaque “educationese” language, it was quite satisfactory. There was a further useful revision in 2008, with minor changes in content. The emphasis, in this curriculum, is not just on content, but on science skills and literacy, and on awareness of science careers.

The next challenge was reviewing the textbooks, which are so important to both students and teachers. Publishers cannot always find writers who are conversant with astronomy and astronomy teaching (and I was not interested in once again doing it myself). But I did put many tens of hours into much-needed reviewing of the textbooks, in both 1999 and 2008.

The final challenge—and a major one—was providing resources and workshops for teachers, few of whom have any background in astronomy or astronomy teaching. Many leave astronomy to the end of the course, or leave it out completely. With the demise of the McLaughlin Planetarium (part of the Royal Ontario Museum) in 1995, there was no longer the option of covering astronomy by sending the class to a planetarium show, though the Ontario Science Centre has picked up much of the slack with their workshops, exhibits, and planetarium programs, and the Royal Ontario Museum still gives astronomy programs using small, inflatable planetaria.

## Projects for International Year of Astronomy

International Year of Astronomy 2009 provided an excellent opportunity to spread the word about astronomy to a wide audience by partnering with organizations such as STAO. With support from the National Research Council, the University of Toronto Department of Astronomy and Astrophysics and the Dunlap Institute, and the Canadian Thirty-Metre Telescope Project, we—a team of experienced teachers, with me and STAO professional development co-ordinator Malisa Mezenberg as managers—developed online resources for both the grade-6 and -9 astronomy units<sup>3</sup>. The challenge then was to bring these to the attention of teachers, and make them comfortable in teaching with them, ideally, by providing focused workshops. STAO does this regularly at their annual conference. Please help us to publicize these resources!

## New Generation, New Initiatives

I’ve now been involved in school astronomy education for exactly half a century and am keen to see a new generation of colleagues take over. One of the mandates of the University of Toronto’s Dunlap Institute is public education and outreach. The university’s astronomy group held a mini-retreat in the summer of 2013, specifically to consider how they might

support teachers. Several grad students, post-docs, and young astronomers were happy to help. Some had taken a short course in Inquiry-Based Teaching from the Professional Development Program<sup>4</sup> of the Institute for Scientist and Engineer Educators. The Dunlap Institute is now a node of this program. Graduates of this program learn basic principles that most university instructors are not exposed to: the curriculum should begin with objectives, and be designed backward from these; student engagement is essential for effective learning; the curriculum should include the development of critical thinking and other skills, not just content; the designers should keep in mind, right from the start, how they are going to assess the teaching and learning; and they should leave the students with a positive feeling about astronomy, and astronomers.

A dozen of us met with teachers, who gave us a long wish-list of ways in which we could help, headed by the need for inquiry-based activities in which students could develop and use science skills, using real data (if possible), both during the course, as year-end culminating projects, and as enrichment. There was also a need for user-friendly resources for key topics in the curriculum, especially topics that were engaging, but that teachers did not feel knowledgeable about: cosmology and exoplanets, for instance. My young colleagues are now hard at work, developing the first of these activities for presentation at the 2014 STAO conference.

## Reflections

The curriculum that I have described above is the *intended* curriculum. The *taught* curriculum is often much less than this, especially if teachers leave astronomy to the last week of classes, or omit it altogether. We must help them to feel more enthusiastic and confident about this part of the science curriculum. Finally, there is the *learned* curriculum. Many students retain or develop misconceptions about astronomical topics (such as the cause of the seasons) as a result of less-than-satisfactory teaching and textbooks. This can result in a net learning of zero in the course (Sadler, 1992). Critical thinking or science literacy is a key goal of the curriculum, and we must help astronomy teachers to deal with this. Astronomy is rife with misconceptions and widely-held pseudoscientific beliefs.

We hope that the school astronomy curriculum will introduce students to the big ideas and the wonder of astronomy, and leave them with a sense of enthusiasm about the subject. We hope they will also learn that Canada is a leader in astronomy, that there are careers to be had in it as well as related fields, that they can do astronomy as a hobby (thanks in part to the RASC), or simply enjoy reading about it and appreciating the night sky—something that they can do for a lifetime. \*

*John Percy is Professor Emeritus, Astronomy & Astrophysics and Science Education, University of Toronto, and Honorary President of the RASC.*

## Endnotes

- 1 [stao.ca/Home/](http://stao.ca/Home/)
- 2 [www.astrosociety.org/edu/publications/tnl/56/tnl56.pdf](http://www.astrosociety.org/edu/publications/tnl/56/tnl56.pdf)
- 3 [stao.ca/res2/astronomy-2.php](http://stao.ca/res2/astronomy-2.php)
- 4 [isee.ucsc.edu/programs/pdp/index.html](http://isee.ucsc.edu/programs/pdp/index.html)

## References

- Andrews, W.A. *et al.* (1988), *Science 10: An Introductory Study*, Scarborough, Ont.: Prentice Hall Canada.
- Barbour, I. (2000). *When Science Meets Religion*. San Francisco: Harper.
- Bishop, J.E. (1990), in *The Teaching of Astronomy*, ed. J.M. Pasachoff and J.R. Percy. Cambridge University Press, 253.
- Ewers, R.O. and Ewers, L.M. (1976). *A Universe to Explore* (pp 92). Toronto: Holt, Rinehart and Winston of Canada, Ltd.
- MacBean, J.C. *et al.* (1973). *Astronomy: Examining Your Environment* (pp 97). Toronto: Holt, Rinehart and Winston of Canada, Ltd.
- Paul, D., Peirce, D., and Stief, K. (1973). *Motion in the Heavens*. Toronto: Holt, Rinehart and Winston of Canada, Ltd. Pp. 150.
- Percy, J.R. and Percy, C.E. (1986). *A Teachers' Guide to Astronomy* (pp 237). Erindale College, University of Toronto. Pp. 237.
- Percy, J. R. (2005). In J. M. Pasachoff & J. R. Percy (Eds.), *Teaching and Learning Astronomy* (pp 10). Cambridge, UK: Cambridge University Press.
- Sadler, P.M. (1992), *The Initial Knowledge State of High School Astronomy Students*. Ed.D. Thesis, Harvard University.



**SERVING AMATEUR ASTRONOMERS FOR OVER 22 YEARS!**

**toll-free 1-800-580-7160**  
**info@khanscope.com**

**www.khanscope.com**

**All Major Brands of Telescopes including:**  
 Meade | Celestron | TeleVue | Coronado | APM  
 SkyWatcher | William Optics | Rigel | Baader  
 Nikon | Antares | Telrad | Denkmeier | Equinox  
 Thousand Oaks | Kendrick | Lunt Solarsystems  
 TeleGizmos | Ioptron | Sky Pub & Others

**NEW | USED | TRADE-INS**  
**WE SHIP CANADA WIDE**

**KHAN SCOPE CENTRE**

3243 Dufferin Street, Toronto, ON M6A 2T2  
 Phone: 416 783 4140 | Fax: 416 352 1701

## Fun With Arduinos—Part 3

# Anti-Dew Heat Control by Arduino



by Rick Saunders, London Centre  
(ozzy1@gmail.com)

The power-box project has grown into a kind of Swiss Army knife with the addition of a micro-controller-driven, anti-dew heater and various sensors. I've written previously on power distribution, so this article will be on the anti-dew, heat-control system only. If someone wishes to integrate the two, just drop me a line.



Figure 1 — The front panel.

The heart and soul of the system are an Arduino Nano clone and a PowerFET (field-effect transistor). The Nano has several PWM-capable (Pulse Width Modulation) pins that can control the brightness of LEDs and that can turn the FET on or off in a programmable manner to allow a specific amount of current to be delivered to a heat strip (or strips).

The device in this article has the following features:

- Voltage monitoring with low-voltage heat shutoff
- Current monitoring with over-current display and heat shutoff
- Temperature and relative humidity monitoring
- Front-panel LEDs to indicate the various parameters
- Local control via potentiometer
- Computer control via a USB-Serial connection

### Voltage and Current Monitoring

Voltage is monitored by using a simple voltage divider consisting of two 1-percent resistors. The values of these are 1000 ohms on the +12V side and 2000 ohms on the ground side. The junction of the two provides a voltage between 0 and

5V that follows the battery voltage, which is connected to one of the Nano's analogue-to-digital pins. The voltage state is indicated by two LEDs.

The power LED is on continuously when the voltage is good. When the voltage drops below a pre-programmed Low Voltage Warning level, the power LED will blink slowly, but heat is still provided. When the voltage drops below a pre-programmed, low-voltage-shutoff level, the anti-dew heat is turned off and the LED will blink rapidly. At this time the heat LED will blink in time with the power LED.

The current being used by the unit is monitored by an ACS758 Hall-effect sensor that is connected to the 12V input to the device. The sensor is also connected to another of the Nano's ADC pins and the state of the current level is indicated by a third LED on the front panel. This LED follows the current level and flashes slowly when the high-current warning level is attained and quickly when the maximum current level is reached (both settable). If the system reaches an over-current state, the heat is shut off.

### Local Anti-dew Heat Control

Local control of the amount of heat being delivered is done by turning the potentiometer on the front panel. A fourth LED, the anti-dew heat LED, brightens and dims to match the current being delivered to the heat strips. If either the voltage drops too low or the current draw is too high, the anti-dew heat system is shut off and the LED flashes (see above).

### Temperature and Relative Humidity

These are both monitored by a DHT22 sensor mounted on the rear panel. It is connected to yet another ADC pin on the Nano. The relative humidity (RH) LED changes brightness from off at 0 percent to full on at 100 percent. Additionally, at 75 percent RH, the LED will start to blink slowly and at 90 percent it will blink rapidly. These are to tell you that you may need to turn up the heat. The actual values are shown by the software when the unit is connected and running in remote mode.

#### Is your address correct?

#### Are you moving?

*If you are planning to move, or your address is incorrect on the label of your Journal, please contact the office immediately.*

*By changing your address in advance, you will continue to receive all issues of SkyNews and the Observer's Handbook.*

(416) 924-7973

[www.rasc.ca/contact](http://www.rasc.ca/contact)

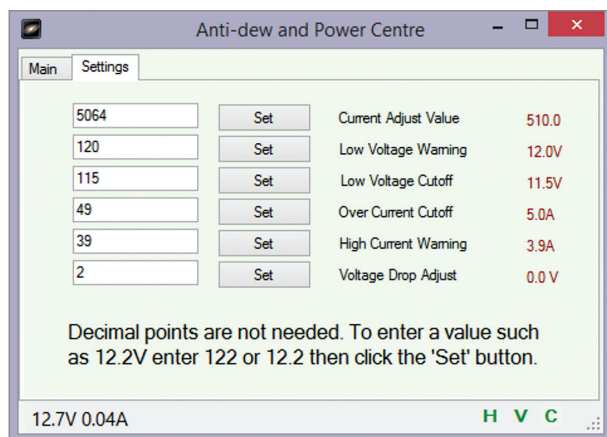
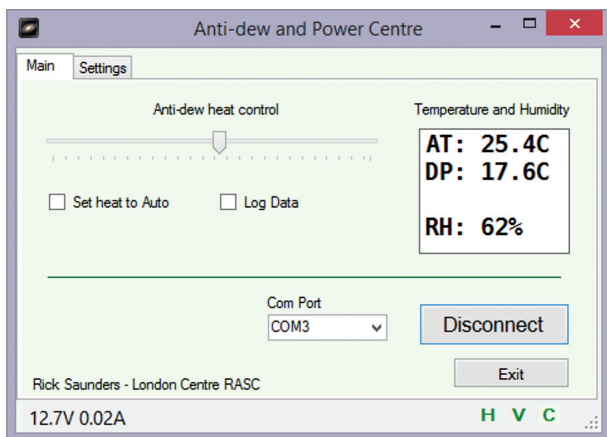

Figure 2 — The Ozheat display panel.

## Computer Control

Computer control of the device is via USB-Serial. The serial interface is built into the Nano and is connected by a simple USB cable. A small *Windows* program I've written in VB.net controls everything. When the software is connected, the front-panel potentiometer is disabled, but the LED will indicate the level of heat called for by the software.

The software is quite simple. Select the COM port and the combo boxes and click "Connect." The heat-control slider is positioned according to the value that was last set by the pot. Temperature and humidity data are shown, as are the battery voltage and the device's current draw. Along with the slider, there is a checkbox that enables "automatic heat control." This is very rudimentary and is based solely on humidity. When "Auto" is selected, the heat LED on the device will fade in/out slowly. On the "Settings" tab are all the variables needed to allow the function of the device to be customized.

The software will keep track of the com port that was last used. This is saved in a file in Documents called "lastport.txt." Other than the first time the software is used, you won't have to try to remember what com port the anti-dew box is on (I could write auto-detect routines in... Maybe later).

## Logging Data

Checking the "Log Data" box will tell the software to log all of the sensor readings and heat setting every minute. If you use a library of dark frames, this might come in handy. The data might also be useful in tuning the auto-heat function of the Nano (some knowledge in C programming necessary).

## The Build

The device sits on a small piece of perfboard. The Nano is soldered in (or put into a socket that is soldered in) and the various connections soldered to the bottom or the top of the Nano's pins. It can get to look like a mess, but it works. Note the diode on the diagram (Figure 3). If the 12V is unplugged and the USB is plugged in, the Nano will attempt to power the whole circuit with 5V. This would be a bad thing. Put the diode in the 12V line to the Nano with the bar on the diode on the Nano side.

Don't forget to connect the 12V and ground from the battery to the Nano and make sure that the ground goes to any other boards or parts that you include. Missing these mean that the device won't work unplugged from a computer. The resistors in line with the LEDs aren't critical—anything around 1000 ohms will work.

The parts you'll need are not expensive and can all be had on eBay from China. You just have to wait patiently for them to make the trip across.

## Bill of Materials

### eBay Listings

Mini USB Nano V3.0 Atmega328P	\$7.75
DHT22 Digital Temperature/Humidity Sensor	\$4.39
IRFZ44N PowerFET TO220	\$0.94
5 pc RCA Jack Panel Mount	\$5.18
10 pc 5-mm Red Water Clear LED	\$1.99
2 pc Double Side Tinned Prototype Board	\$1.99
10K Linear Potentiometer with Knob	\$4.99
10 pc Right Angle Terminal Block	\$1.99
Allegro ACS758 Hall-effect Current Sensor	\$7.12

### From Mouser.ca

LH55-130 Kit Pactec Desktop Enclosure (shipping extra)	\$11.00
---	---------

**Note:** You might get better prices on single pieces from Radio Shack or other hobby suppliers. The enclosure is available more cheaply direct from the manufacturer (Pactec), but shipping may be more. All above, except the Pactec enclosure, are shipping included. All prices in U.S. dollars.



Figure 3 — Schematic of the board layout.  
The thick lines need to be able to carry several amperes. Don't use thin wire.

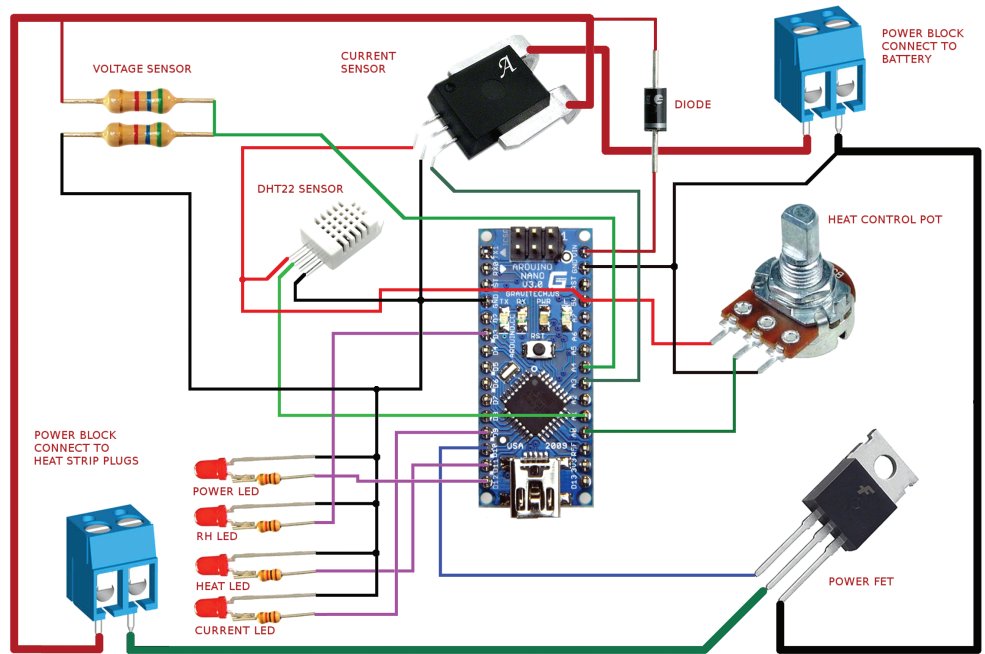

Other things you'll need that'll cost you a couple of dollars

- 4 small resistors in the range of 820 to 2000 ohm
- 1 small rectifying diode
- Solder
- Wire 20AWG and 28AWG (or similar)

You'll also need some way of getting power in. I used multi-mode connectors. Banana plugs would be good. Good quality RCA or DC barrel jacks would work but can be pulled out easily.

All done, you should be able to build a very useful box for less than \$75 (including the internal liniment needed to help recover from solder fumes). I've included a wiring diagram showing how things are connected. An Eagle schematic and board layout along with the Arduino sketch can be found at [www.togastro.com/ozzzy/anti-dew.zip](http://www.togastro.com/ozzzy/anti-dew.zip).

## Tuning the Device

### Current Adjustment

The default setting in the Settings tab is 5100. If you notice an error in the current being reported, this can be changed to better reflect the actual current use. For my equipment, the setting is 5064. Set the unit up with all your stuff plugged in, and measure the current draw with an ammeter. Then adjust the value in the Settings tab until your current reads the same as the ammeter. Don't worry if the very low values when nothing is plugged in don't read correctly. This is a function of the large range of the ACS758 (ones with smaller ranges are available). I'm more worried about high current than low current.

### Voltage

It's the nature of electricity that when you have the device loaded down there will be some voltage drop at the unit; the readout may say 12.3V when the value measured at the battery is 12.5. This can be taken into account with the Voltage Drop Adjust setting. Just change the value to "2" and when everything is loaded down, the battery voltage will read more accurately. Of course, you can just set the limits in the Settings tab offset by .2V to handle it and ignore the readout.

Have fun with this build and feel free to ask me any questions you might have. ★

*Rick Saunders became interested in astronomy after his father brought home a 50-mm refractor and showed him Saturn's rings. Previously a member of both Toronto and Edmonton Centres, he now belongs to the London Centre and is mostly interested in DSLR astrophotography.*



**Ontario Telescope  
and Accessories**

tel. 905-487-6363

<p><b>Proud seller of</b></p> <ul style="list-style-type: none"> <li>iOptron</li> <li>Bresser</li> <li>Explore Scientific</li> <li>Antares</li> <li>Bob's Knobs</li> <li>Lumicon</li> </ul>	<p><b>Your Online source for</b></p> <ul style="list-style-type: none"> <li>"GoTo" EQ and Alt/Az mounts</li> <li>Telescopes</li> <li>Finderscopes</li> <li>Camera mounts</li> <li>Mechanical adapters and Accessories</li> </ul>
<a href="http://www.ontariotelescope.com">www.ontariotelescope.com</a>	
Ontario Telescope and Accessories, Where OTA means more!	

# Second Light

## Things That Go Bang in the Night



by Leslie J. Sage  
([l.sage@us.nature.com](mailto:l.sage@us.nature.com))

Supernovae have traditionally been classified as type I (no hydrogen lines in the spectra), or type II (with hydrogen lines). In the past 40 or so years, the categories have proliferated, both because of better instruments and a better theoretical understanding of what is happening physically in the progenitor star. We now know that, in general, type II supernovae arise from a massive star. The progenitor of supernova 1987A was found on archival images of the Large Magellanic Cloud. Type Ia—the kind used for cosmology—are brighter and seem to be the explosion of a white dwarf that approaches the Chandrasekhar limit for stability (about 1.4 solar masses). It has proven to be very hard to pin down how the white dwarf comes to explode. The two basic options are accreting gas from a main-sequence or giant companion or the merger of two white dwarfs. For now, the circumstantial evidence is trending in favour of the merger of two white dwarfs. Saurabh Jha and his graduate student, Curtis McCully, of Rutgers University, and their collaborators around the world, think they have found the progenitor system of a type Iax supernova (see the 2014 August 7 issue of *Nature*). The supernova, SN 2012Z, exploded in the nearby galaxy NGC 1309. As implied by the “Iax” designation, they are thought to be related to type Ia supernovae.

Type Iax supernovae have spectra that are similar to type Ia spectra around the time of maximum light, though at later times the properties diverge. The composition of the Iax ejecta is dominated by “iron-group” and intermediate-mass elements such as silicon, sulfur, calcium, *etc.* that also dominate the ejecta of type Ia, which has been taken as an indication that they have similar progenitors. The Iax ejecta have lower velocities, and the leading models for them are explosions of white dwarfs dominated by carbon and oxygen. The model

explosions do not completely destroy (“unbind” in the jargon) the progenitor star and, therefore, they are regarded as cousins of type Ia (which are completely destroyed). As no progenitor of a type Ia has been found, there is considerable interest in the progenitor of a Iax.

Fortuitously, the *Hubble Space Telescope* obtained deep images on NGC 1309 in 2005–2006 and again in 2010, and Jha and McCully obtained a new image in 2013 (Figure 1). They find a star, labelled S1 in the figure, at the same position as the supernova, within the uncertainty arising from the diffraction limit of the HST, which is about 0.01 arcsec. The big question now is whether S1 will still be there when the supernova fades. If it was a binary companion to the white dwarf that exploded, it is possible that the star has been changed by the explosion.

Jha and his collaborators put considerable effort into the analysis of just what S1 might be. Their favoured explanation for the system is that the exploding white dwarf started its life as a  $\sim 7$  solar-mass star with a close companion of  $\sim 4$  solar masses ( $M_{\odot}$ ). The  $7-M_{\odot}$  star evolves more quickly and during its life, dumps about 6 solar masses of material onto the companion and turns it into a  $10-M_{\odot}$  star. The  $1-M_{\odot}$  remnant becomes a white dwarf that is enveloped in the puffed up atmosphere of the  $10-M_{\odot}$  star, an arrangement that is called the “common envelope” phase. During this phase, about  $7.5 M_{\odot}$  of gas—including all the hydrogen in the larger star’s envelope—is ejected, leaving a system of a white dwarf and a  $2.5-M_{\odot}$  companion. Because all the hydrogen is gone, the  $2.5-M_{\odot}$  star is a “helium star.” It evolves into a giant star that is blue and luminous. It is this star that is seen as S1. During its evolution it dumps about  $0.4 M_{\odot}$  of gas onto the white dwarf, taking it near the stability limit and causing the explosion.

McCully *et al.* point out that there may be an analogue to SN 2012Z and S1 in our galaxy: the helium nova V445 Puppis. This system is thought to be composed of a white dwarf near the Chandrasekhar stability limit accreting helium from a nearby, evolved companion. And, in fact, two earlier type Iax supernovae (but not 2012Z) have shown evidence for helium in their spectra. In this picture, a low rate of accretion onto the white dwarf in V445 Pup could lead to periodic explosions as

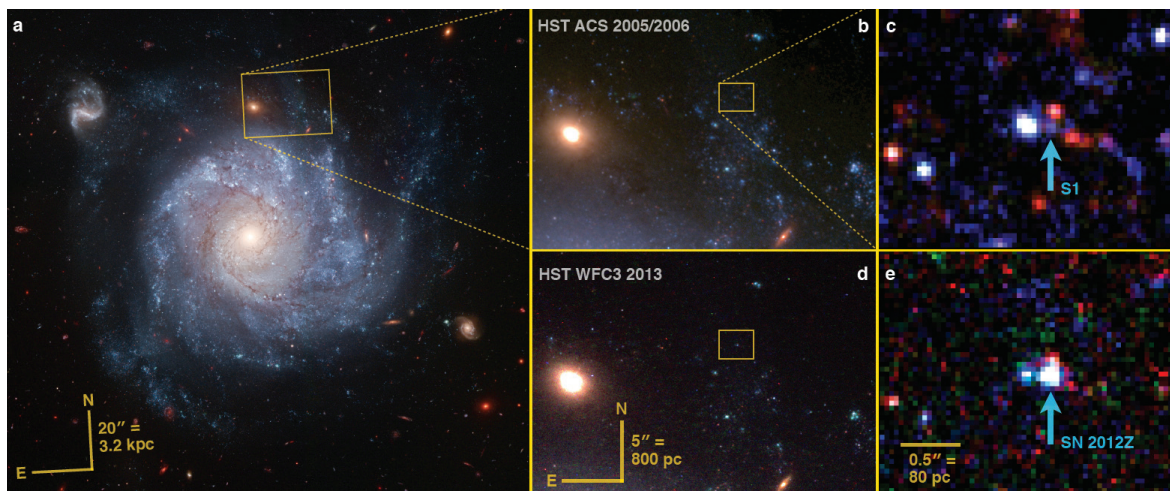

Figure 1 — Panels a-c show the pre-explosion images, with S1 identified in panel c. Panels d and e are post-explosion. Images courtesy of NASA/Nature/Saurabh Jha.

a nova, while a higher accretion rate could cause the mass of the white dwarf to increase until it hit the stability limit and exploded as a supernova.

As I indicated earlier, circumstantial evidence has been accumulating over the past few years that type Ia supernovae result from the merger of two white dwarfs. It will be very interesting to see if S1 is a helium star. That might then imply that the difference between type Ia and Ia<sub>x</sub> supernovae could be the means by which mass is delivered to the white dwarf: all at once in a merger, for the type Ia, and a trickle from a

companion for the Ia<sub>x</sub> events. I am looking forward to what will be revealed in a couple of years, when the light from the supernova fades; perhaps I will be able to report the resolution of the question in a new column at that time. ★

*Leslie J. Sage is Senior Editor, Physical Sciences, for Nature Magazine and a Research Associate in the Astronomy Department at the University of Maryland. He grew up in Burlington, Ontario, where even the bright lights of Toronto did not dim his enthusiasm for astronomy. Currently he studies molecular gas and star formation in galaxies, particularly interacting ones, but is not above looking at a humble planetary object.*

---

## Reviews / Critiques

---

**Dreams of Other Worlds: The Amazing Story of Unmanned Space Exploration**, by Chris Impey and Holly Henry, 472 pages, 16×24 cm, Princeton University Press, 2013. Price \$39.33 CAD, hardcover (ISBN: 9780691147536).

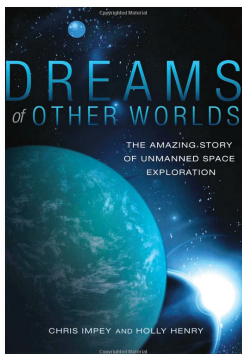

Our view of the Solar System and indeed of our Universe has undergone dramatic and startling changes in the past half century. We are all familiar with many of the advances in astronomy and physics, and with the exploits of astronauts who have flown into space, all the way to the Moon.

But many discoveries have come to us courtesy of robots that we have dispatched into Earth orbit, around the Solar System, and in a couple

of cases, beyond. When we ponder these discoveries, our attention is directed to other spacecraft such as *Voyager*, which gave us our first look at the outer Solar System, the Viking landers and the rovers that are exploring Mars, and the *Hubble Space Telescope* with its stunning images.

But many more satellites and spacecraft have explored our Solar System and have helped unlock the mysteries of the Universe beyond, and in some cases, opened our eyes to new mysteries that need to be deciphered. The stories of these space explorers and others are covered in *Dreams of Other Worlds*, written by University of Arizona astronomy professor Chris Impey and English professor Holly Henry. The book is not a story of the space race or of the hardware that has made the discoveries, but of the science produced by these spacecraft and the people and ideas behind the science.

*Dreams of Other Worlds* begins with well-known robotic explorers: the Viking Mars lander; the Spirit and Opportunity rovers that have explored Mars in recent years; *Voyager*; the *Cassini* spacecraft that continues its dazzling exploration of the Saturnian system; and the *Hubble* telescope. The book then turns to lesser-known spacecraft such as *Stardust*, *SOHO*, *Hipparcos*, *Spitzer*, *Chandra*, and WMAP, the *Wilkinson Microwave Anisotropy Probe*. That small list omits many

well-known spacecraft of the past, such as the *Mariners* that explored the inner Solar System along with the *Pioneers* and other craft, but this book is not a reference book on every space probe launched to every object. Instead, the authors focus on how discoveries made in space have changed our view of the Universe and of our home planet.

Impey and Henry often take unexpected turns in their discussions of space exploration. In their account of the early exploration of Mars, the two show how interest in life on the Red Planet caused scientists to reconsider the place of life on Earth. We learn that a little-known spacecraft, SOHO or the *Solar and Heliospheric Observatory*, is one of the most important explorers ever launched, because it monitors the Sun, whose behaviour is much more dynamic than most of us realize. Solar storms can and have occasionally knocked out our communications and power systems, for example. In addition to providing warning of these storms, SOHO has discovered thousands of comets, upending our ideas about those wanderers of the Solar System.

Much of the book is focused on the great spaceborne observatories such as *Hubble*, *Chandra*, and *Spitzer*, which have revolutionized our knowledge of the Universe with their multi-wavelength sensors. The book also features results from spacecraft such as *Kepler*, which is so much in the news today as analysis continues on the data collected in its search for planets around other stars.

*Dreams of Other Worlds* is highly recommended for those interested in getting up to date with astronomical discoveries made from space. Moreover, its thoughtful approach contains insights for almost anyone interested in space science. This book discusses the highlights, but it shouldn't be considered a reference book, as it doesn't cover every spacecraft and passes quickly over the Moon and the inner Solar System.

It is clear that the book was largely finished two years ago. Astronomy, cosmology, and planetary science are moving at a fast pace today, and over time, many of the ideas contained in this book will be out of date. But for anyone wanting to catch up on the many areas of space exploration that don't get the headlines they deserve, *Dreams of Other Worlds* is highly recommended. ★

*Chris Gainor is Second Vice-President of the RASC and a historian of space exploration.*



Figure 4 (top left) — Outgoing President Glenn Hawley presents the Service Award to Journal Editor-in-Chief Jay Anderson. Photos (all): David Clark

Figure 5 (top right) — “The Queen” prepares to behead, er... beknight “Sir” Randall Rosenfeld.

Figure 6 (middle) — A sense of humour is always good—quite evident in the UVic Astronomy Department!

Figure 7 (bottom) — 2nd Vice-President Chris Gainor and President Glenn Hawley make presentations to outgoing CASCA President, Laura Ferrarese. Dr. Laura was this year’s Hogg Lecturer, and is the recipient of the Hogg Memorial Award for 2014.

# A Note from the 2014 General Assembly Organizing Committee

RASC VICTORIA CENTRE

2014 General Assembly Organizing Committee

Mark Bohlman, Co-Chair (mbohlman@shaw.ca)

Paul Schumacher, Co-Chair (docpschu@shaw.ca)

RASC GENERAL ASSEMBLY, 2014 June 26 – 29

The 2014 RASC General Assembly at the University of Victoria showcased the historic Dominion Astrophysical Observatory, UVic's new observatory located on campus, and a wide-ranging scientific and cultural schedule of events as it celebrated the 100th anniversary of the Victoria Centre, all conducted against the spectacular natural beauty of Canada's West Coast. Guest Speakers included Dr. Laura Ferrarese of the National Research Council, Bob McDonald of CBC's *Quirks and Quarks*, Dr. Andy Pon from Leeds, England, and the RASC's own Peter Broughton.

The Victoria Centre and the GA Organizing Committee wishes to thank everyone who joined us at the GA from June 26 to 29. It has been fun making new friends, renewing old friendships, and exploring the beauty of Vancouver Island.

The 2015 GA Organizing committee invites you to join them in Halifax, Nova Scotia, 2015 July 1 – 5. ★

# Quasar Crossword Answers

by Naomi Pasachoff

M	A	T	S		C	A	R	O	M		E	C	R	U
A	H	A	T		O	M	A	R	A		M	R	I	S
I	O	T	A		S	E	V	E	R		B	A	N	E
	E	I	N	S	T	E	I	N	C	R	O	S	S	
				D	U	S	K			A	S	H	E	
A	R	S	O	N		E	D	E	N	S				
L	O	A	F		M	O	D	U	L	I		G	N	U
S	E	Y	F	E	R	T	G	A	L	A	X	I	E	S
O	S	S		M	O	T	E	L	S		A	L	M	S
				M	E	R	O	S		E	N	D	O	R
	P	A	C	E				T	I	N	T			
	A	C	C	R	E	T	I	O	N	D	I	S	K	
A	R	C	O		T	O	R	T	E		P	A	I	L
V	E	R	Y		A	R	M	O	R		P	I	N	E
E	R	A	S		L	E	A	S	T		E	L	K	S

RASC members receiving this *Journal* in electronic format are hereby granted permission to make a single paper copy for their personal use.



# Astrocryptic

by Curt Nason

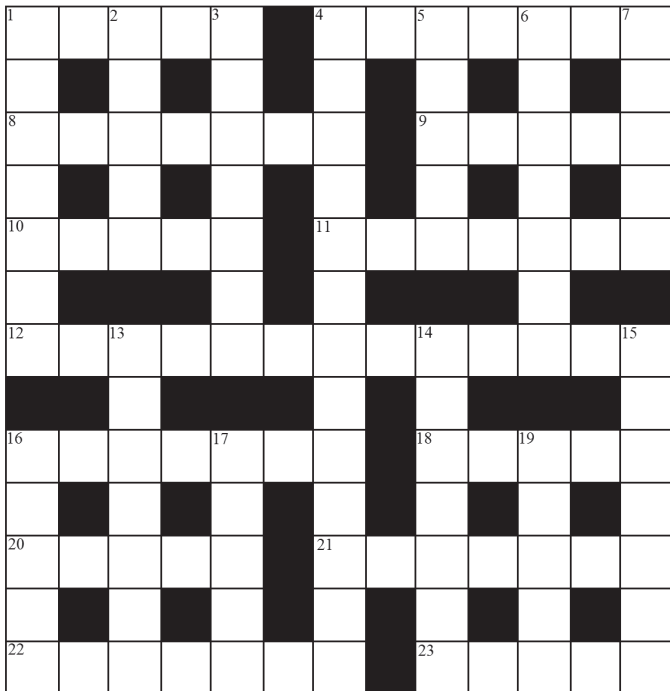

## ACROSS

1. Nagler backs limited service of pointers (5)
4. A Cassini comet of 2014 (7)
8. Orbits start in front of Jupiter for Io (7)
9. Bear the burden of equatorial alignment (5)
10. It loses half of energy within to become unreactive (5)
11. Darn it! A strange place to look for meteors (7)
12. Annually, he keeps us up on a ruly Mars (6,7)
16. Stellar evolution charter slews around between right and left (7)
18. Tyson's role model attends a GA between the poles (5)
20. Aries backs around at the foreleg of Pegasus (5)
21. Imagine, e.g., swapping modern astrophotography (7)
22. Barnard's middle defined, re: meson spin (7)
23. Godly flautist holds Albert Einstein to sing praises of Apollo (5)

## DOWN

1. Drone eats one after set on fire by Big Bang remnant (7)
2. Room, and lots of it here (5)
3. Round treats scattered around a comet rounder (7)
4. Laboratory with a joint purpose scrambling around lunar start-up (3,10)
5. Famous archer from Venus (5)
6. UPS lad slews around a hole and delivers program changes to a satellite (7)
7. Opportunity's partner lost one on a mast (5)

13. Scrambling to reset colourful nebula (7)
14. Masking process of rotating sun by Lyra (7)
15. Harp in midday about the shape of a wooden Newtonian tube (7)
16. Unusual crater lip backs each of the lunar rills (5)
19. Somewhat sure about nothing, they buy telescopes in France (5)
29. Imaging scope for a girls' camp? (5)

## Answers to August's Astrocryptic

### ACROSS

- 1 BEALS (anag); 4 CEPHEUS (2 def, circumpolar); 8 MECHAIN (me + chain = links); 9 OPTIC (anag); 10 SPOKE (2 def); 11 EMITTER (ret + time, rev); 12 THE FLY (2 def, Vincent); 14 FORNAX (fo(nar)x); 17 RETICLE (anag less c); 19 ALULA (Gene Vincent's Be bop a lula); 21 ZOSMA (O + ZAMS anag); 22 SANDAGE (anag); 23 DANIELL (d(ani)ell); 24 BINOS (anag)

### DOWN

- 1 BUMPS (b + umps); 2 ALCYONE (anag + one); 3 SCALE (2 def); 4 CANCER (ca(NC)er, anag); 5 PHOTINO (phot(in)o, rev); 6 ESTAT (hidden); 7 SYCORAX (sy(co)rax, anag); 12 TARAZED (t(ara)zed); 13 LACTATE (lac(tat)e); 15 NEUMANN (anag); 16 BESSEL (be + less, rev); 18 TYSON (anag); 19 ARNEB (hid); 21 ATENS (anag + S)

## It's Not All Sirius

by Ted Dunphy

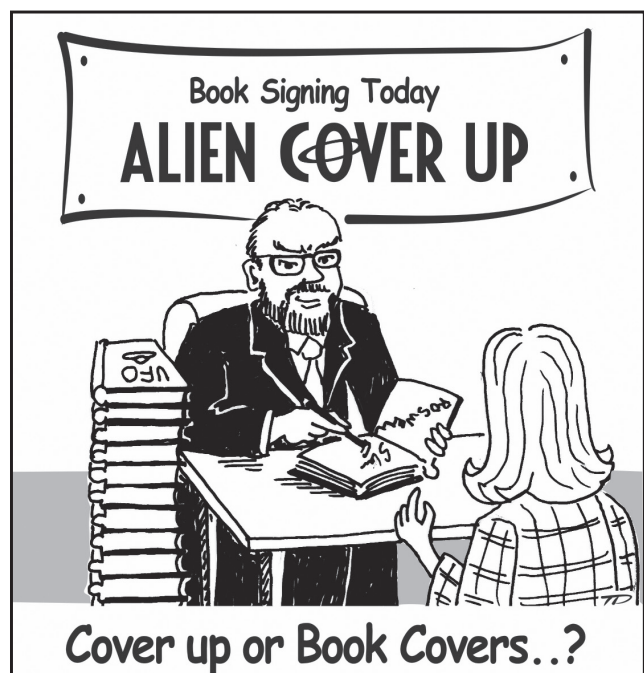

# THE ROYAL ASTRONOMICAL SOCIETY OF CANADA

Board of Directors and appointed officers for 2014/2015 | Conseil d'administration et membres attirés pour 2014/2015

## Honorary President

John R. Percy, Ph.D., Toronto

## President

James Edgar, Regina

## 1st Vice-President

Colin Haig, B.Sc., M.Sc., Hamilton

## 2nd Vice-President

Chris Gainor, B.A., M.Sc., Ph.D., Victoria

## Secretary

Karen Finstad, M.A., Ph.D., Ottawa

## Treasurer

Denis Grey, B. Math., M.B.A., Toronto

## Director

Randy Boddam, C.D., B.Sc., M.D., F.R.C.P.C.,  
Belleville

## Director

Robyn Foret, Calgary

## Director

Craig Levine, M.A., London

## Director

Paul Schumacher, D.D.S., M.T.S., Victoria

## Past President

Glenn Hawley, B.Sc., B.Ed., Calgary

## Executive Director

J. Randy Attwood, B.Sc., FRASC

## Editors

### Journal

Jay Anderson, B.Sc., MNRM, Winnipeg

### Observer's Handbook

David M.F. Chapman, M.Sc., Halifax

### Beginner's Observing Guide

Brenda Shaw, Toronto

### eBulletin

Dave Garner, B.Sc., M.o.A., Kitchener-Waterloo

### Observer's Calendar

Paul Gray, Halifax

## Great Images

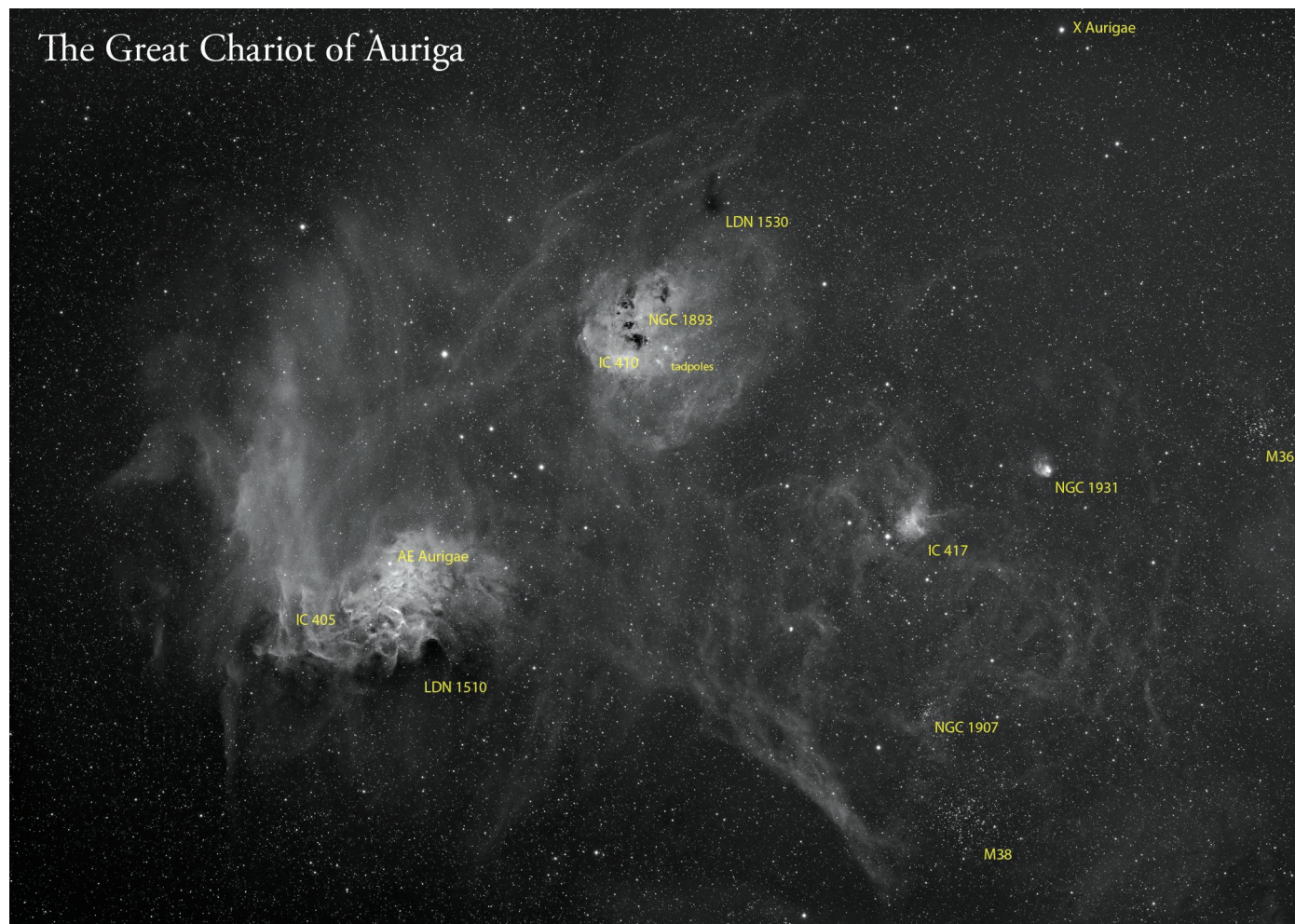

*Auriga, the Charioteer, is an often overlooked constellation of marvellous nebulae and clusters. The constellation itself is a bit of a mystery, as the identity of the Charioteer is lost in the mists of history. James Black provides us with this annotated H $\alpha$  image of the heart of the constellation, showing the extensive nebulosity and three of its open clusters. James used a Takahashi FSQ106ED and a Starlight Xpress SXVR-H36 camera to collect the photons for this mosaic through a Baader 7-nm H $\alpha$  filter from his Light Waves Observatory.*



# Journal

## Great Images

*This narrowband, false-colour image shows the "Great Wall" in the North American Nebula in Cygnus. Shawn Nielsen collected the photons from Kitchener, Ontario, within the Waterloo region with a population of 500,000+ and lots of light pollution. The colours are reconstructed from 3 hours of H $\alpha$  and 2 hours of OIII data using a variant Hubble palette. Shawn used a modified Canon T1i to gather the H $\alpha$  data and an SBIG 8300M CCD for the oxygen, both on a Williams Optics Zenithstar APO refractor. In Shawn's words, "... narrowband opens up a whole new world of astrophotography for those living within the cities but still having a desire to capture images of their favourite deep-sky wonders!"*