

The Journal of The Royal Astronomical Society of Canada

Journal

Le Journal de la Société royale d'astronomie du Canada

PROMOTING
ASTRONOMY
IN CANADA

October/octobre 2013
Volume/volume 107
Number/numéro 5 [762]

Inside this issue:

**David Levy, Fireflies,
and Arcturus**

David Levy Comes Home

Astronomers Kiss and Tell

Rendezvous with the Stars

Tribute to Jim Hesser

**Strategies for Making
Friends**

David Levy among the stars

Astrophotographers take note!

This space is reserved for your B&W or greyscale images. Give us your best shots!



Steve Holmes is an aficionado of narrowband H α photography, as seen in this image of the Cygnus wall—the ridge of high emissivity in the North America Nebula that gives form to the Central America portion. The Wall is an ionization front where high-energy ultraviolet light encounters a high-density portion of the dust and gas that makes up the nebula.

contents / table des matières

Feature Articles / Articles de fond

- 186 **David Levy, Fireflies, and Arcturus**
Grace the London Centre
by Dale Armstrong
- 187 **David Levy Comes Home**
by Randy Attwood
- 188 **Astronomers Kiss and Tell—Imperfections Revealed**
by Richard J. Legault
- 199 **What to Do When the Astrologer Crashes**
Your Star Party: Strategies for Making Friends
and Influencing Enemies
by R.A. Rosenfeld
- 202 **Rendezvous with the Stars and the Universe, Too**
by Maureen Arges Nadin
- 207 **A Tribute to Jim Hesser**
by John R. Percy

Columns / Rubriques

- 203 **Pen and Pixel Extra:**
Scenes from the General Assembly
- 205 **Pen and Pixel: Helix Nebula / Conjunction /**
Noctilucent Clouds / Cocoon Nebula
Randy Krall / Joel Parkes / Sheila Wiwchar / Lynn Hilborn
- 209 **Through My Eyepiece: The Big Picture**
by Geoff Gaherty
- 210 **Cosmic Contemplations: An Ultraportable Open,**
Folded, 8.5-inch *f*/12.5 Refractor
by Jim Chung



Front cover — David Levy and Kingston Centre President Sue Gagnon observe from the Lennox and Addington Dark-Sky Viewing Area. David shows Sue the area in the sky where he discovered his first comet. Photo: Terence Dickinson.

- 212 **Imager's Corner: Recovering Star Colours**
by Blair MacDonald
- 214 **Rising Stars: Peter McMahon—From *Star Wars* to**
***SkyNews* and Beyond**
by John Crossen
- 216 **Cheap Stuff From China: Doing Astro-stuff with a**
Raspberry Pi
by Rick Saunders
- 219 **On Another Wavelength: The Lunar Atmosphere**
and Dust Environment Explorer
by David Garner
- 220 **Second Light: Enceladus's Tidally Driven**
"Tiger Stripes"
by Leslie J. Sage

Departments / Départements

- 182 **News Notes/En manchettes**
Compiled by Andrew I. Oakes
- Spectrographic analysis establishes exoplanet's colour
 - Report details 2020 Mission to Mars
 - Two Plutonian moons feature mythical names
 - Scientific achievements bring prestigious recognitions
 - Earth and Moon seen from Saturn and Mercury vantage points
 - New robotic telescope LT2 to be double in size
- 222 **Reviews/Critiques**
The Cambridge Photographic Moon Atlas / Introduction to
Planetary Geomorphology / The Quest to Regain Paradise /
Our Enigmatic Universe: One Astronomer's Reflections
on the Human Condition
- 227 **Society News**
by James Edgar
- 228 **Astrocryptic**
by Curt Nason
- 228 **It's Not All Sirius—Cartoon**
by Ted Dunphy

Journal

The *Journal* is a bi-monthly publication of The Royal Astronomical Society of Canada and is devoted to the advancement of astronomy and allied sciences.

It contains articles on Canadian astronomers and current activities of the RASC and its Centres, research and review papers by professional and amateur astronomers, and articles of a historical, biographical, or educational nature of general interest to the astronomical community. All contributions are welcome, but the editors reserve the right to edit material prior to publication. Research papers are reviewed prior to publication, and professional astronomers with institutional affiliations are asked to pay publication charges of \$100 per page. Such charges are waived for RASC members who do not have access to professional funds as well as for solicited articles. Manuscripts and other submitted material may be in English or French, and should be sent to the Editor-in-Chief.

Editor-in-Chief

Jay Anderson
203 - 4920 Dundas St W
Toronto ON M9A 1B7, Canada
Email: editor@rasc.ca
Web site: www.rasc.ca
Telephone: (416) 924-7973
Fax: (416) 924-2911

Associate Editor-in-Chief

Nicole Mortillaro
Email: nmortillaro@gmail.com

Associate Editor, Research

Douglas Hube
Email: dhube@phys.ualberta.ca

Associate Editor, General

Michael Attas
Email: attasm@aecl.ca

Assistant Editors

Michael Allen
Martin Beech
Dave Chapman
Ralph Chou
Ralph Croning
Dave Garner
Patrick Kelly
Gail Wise

Editorial Assistant

Suzanne E. Moreau
Email: semore@sympatico.ca

Production Manager

James Edgar
Email: james@jamesedgar.ca

Contributing Editors

Jim Chung (Cosmic Contemplations)
John Crossen (Rising Stars)
Ted Dunphy (It's Not All Sirius)
Geoff Gaherty (Through My Eyepiece)
Dave Garner (On Another Wavelength)
Blair MacDonald (Imager's Corner)
Curt Nason (Astrocryptic)
Andrew I. Oakes (News Notes)
Randall Rosenfeld (Art & Artifact)
Leslie J. Sage (Second Light)
Rick Saunders (Cheap Stuff From China)
David Turner (Reviews)

Proofreaders

Ossama El Badawy
Margaret Brons
Angelika Hackett
Terry Leeder
Kim Leitch
Suzanne Moreau

Design/Production

Michael Gatto, Grant Tomchuk
Email: gattotomatto@eastlink.ca,
granttomchuk@eastlink.ca

Advertising

Melissa Mascarin
Email: mempub@rasc.ca

Printing

Canselmdc
www.cansel.ca

The *Journal* of The Royal Astronomical Society of Canada is published at an annual subscription rate of \$93.45 (including tax) by The Royal Astronomical Society of Canada. Membership, which includes the publications (for personal use), is open to anyone interested in astronomy. Applications for subscriptions to the *Journal* or membership in the RASC and information on how to acquire back issues of the *Journal* can be obtained from:

The Royal Astronomical Society of Canada
203 - 4920 Dundas St W
Toronto ON M9A 1B7, Canada
Email: nationaloffice@rasc.ca
Web site: www.rasc.ca
Telephone: (416) 924-7973
Fax: (416) 924-2911



Canadian Publications Mail Registration No. 09818

Canada Post: Send address changes to 203 - 4920 Dundas St W, Toronto ON M9A 1B7

Canada Post Publication Agreement No. 40069313

We acknowledge the financial support of the Government of Canada through the Canada Periodical Fund (CPF) for our publishing activities.

Canada

© 2013 The Royal Astronomical Society of Canada.

All rights reserved. ISSN 0035-872X



News Notes / En manchettes

Compiled by Andrew I. Oakes

(copernicus1543@gmail.com)

Spectrographic analysis establishes exoplanet's colour

Planet HD 189733b, orbiting a star 63 light-years away from Earth, is cobalt blue in colour say astronomers studying the exoplanet's reflected light. Using the *Hubble Space Telescope's* Imaging Spectrograph, astronomers have measured changes in the colour of light from the exoplanet before, during, and after a pass behind its yellow-orange star. The planet is a "hot Jupiter," a class of large planets orbiting close to their parent stars.

During observations, researchers saw the light becoming less bright in the blue but not in the green or red. The missing blue light when the object was hidden meant that the planet that disappeared had that colour. Despite its deep-blue-dot appearance, the exoplanet is not considered Earth-like. The daytime temperature on the planet is nearly 1100 degrees Celsius, while the night-side temperatures are lower by about 250 degrees, with fierce winds travelling at about 7200 km/h from the day side to the night side. Discovered in 2005, the exoplanet, only 4.64 million kilometres from its star, is gravitationally locked to its parent, so that one side permanently faces the star while the other side is perpetually dark.

The Royal Astronomical Society of Canada

Vision

To inspire curiosity in all people about the Universe, to share scientific knowledge, and to foster collaboration in astronomical pursuits.

Mission

The Royal Astronomical Society of Canada (RASC) encourages improved understanding of astronomy for all people, through education, outreach, research, publication, enjoyment, partnership, and community.

Values

The RASC has a proud heritage of excellence and integrity in its programs and partnerships. As a vital part of Canada's science community, we support discovery through the scientific method. We inspire and encourage people of all ages to learn about and enjoy astronomy.



Figure 1 — An artist's concept shows a deep-blue exoplanet, HD 189733b, orbiting its yellow-orange star, HD 189733. Image Credit: NASA, ESA, and G. Bacon (STScI)

Astronomers have concluded that the cobalt blue colour comes from a hazy, blow-torched atmosphere containing high clouds laced with silicate particles. Silicates condensing in the heat could form very small drops of glass that scatter blue light more than red light.

Report details 2020 Mission to Mars

NASA is planning to send a new rover to Mars in 2020 that will look for signs of past life, collect samples for possible future return to Earth, and demonstrate technology for future human exploration. The objectives for the mission are outlined in a 154-page report prepared by the Mars 2020 Science Definition Team.

The Science Definition Team, composed of 19 scientists and engineers from universities and research organizations, proposed a mission that would accomplish several high-priority planetary science goals and be a major step in meeting plans to send humans to Mars in the 2030s. NASA plans to conduct

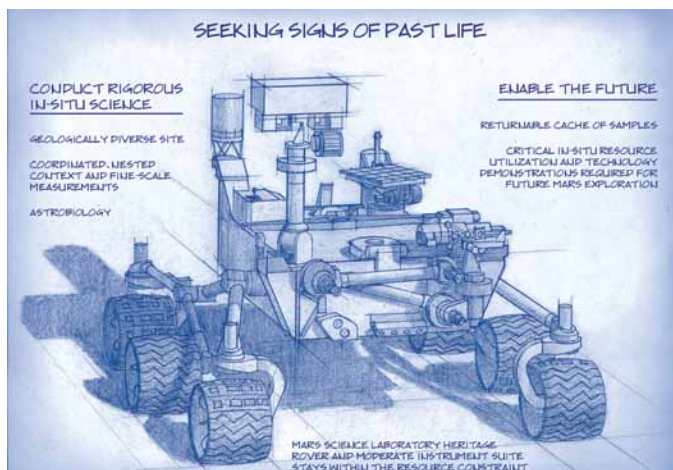

Figure 2 — Artist's concept of Mars 2020 Rover—a basic structure capitalizing on the design and engineering work done for the NASA rover Curiosity, which landed on Mars in 2012. Image: NASA/JPL-Caltech

an open competition for payload and science instruments to be carried by a rover similar to that of Curiosity, currently operating on Mars. Applying Curiosity's design is expected to minimize mission costs, reduce risks, and attain mission objectives.

The new rover configuration would feature a car-sized vehicle about 3 metres long, 2.7 metres wide, and 2.2 metres tall, not including an arm. Instruments on the new rover will permit visual, mineralogical, and chemical analysis down to microscopic scale. The aim is to understand the environment around the landing site and identify biosignatures or features in the rocks and soil that could have been formed biologically.

Looking for signs of past life is the next logical step, notes the Science Definition Team, as Curiosity recently confirmed that past environmental conditions on Mars could have supported living microbes. The Science Definition Team has also proposed that the rover collect and package as many as 31 samples of rock cores and soil for a later mission to bring back for more definitive analysis in laboratories on Earth.

Two Plutonian moons feature mythical names

Pluto's fourth and fifth moons are now officially called Kerberos and Styx. The two new moons were discovered by the *Hubble Space Telescope* in July 2011 and July 2012 during a hunt for rings around the planet. Each is just 10–25 km across.

According to the International Astronomical Union (IAU), any assigned names for the Pluto system required a connection to Greek or Roman mythology. These names refer to a three-headed dog Kerberos (also spelled Cerberus) and a river (Styx) separating the living from the dead.

An international public vote ranked possible names for the moons with the two selected coming in at second and third place. The online survey received over half a million votes. The IAU rejected Vulcan, the first-place winner, noting the name had been used elsewhere in astronomy and was not sufficiently associated in mythology with Pluto, the ruler of the underworld.



Figure 3 — Styx and Kerberos are the names chosen for the two new moons of Pluto. Image: NASA

Pluto itself is a little over 2300 km across. Its other three known moons range in diameter from 1200-km Charon to diminutive Nix and Hydra, in the range of 30–115 km.

In July 2015, the *New Horizons* probe, launched in 2006, is due to fly past the icy world and its moons. The probe features seven instruments designed to carry out detailed mapping of Pluto's surface features, composition, and atmosphere. The spacecraft will pass the planet at a distance of about 10,000 km and Charon by about 27,000 km before pressing onwards.

Scientific achievements bring prestigious recognitions

Astronomer Wendy Laurel Freedman and geophysical researcher Catherine Louise Johnson have recently received prominent recognition for their respective areas of scientific work.

The University of Toronto conferred the honorary degree of Doctor of Science, *honoris causa*, upon Freedman earlier this year during its June 2013 Convocation ceremonies. Already a triple alumna of the U of T, Freedman received her Ph.D. in astronomy and astrophysics in 1984, a Master of Science in 1980, and a Bachelor of Science in astronomy and astrophysics in 1979. Freedman was awarded a Carnegie Fellowship at the Carnegie Observatories in Pasadena, California, in 1984 and later became a member of the permanent faculty in 1987 and the Crawford H. Greenewalt Chair and Director of the Observatories in 2003.

As director, Freedman led an international project to build a 25-metre optical telescope, the Giant Magellan Telescope, to be located in the Andes Mountains in Chile, which is scheduled for completion in 2023. In the 1990s, Freedman also led an international team of astronomers in the Extragalactic Distance Scale project that used the *Hubble Space Telescope* to make a measurement of the Hubble constant accurate to 10 percent, resolving a long-standing debate about the size and age of the Universe. The refined measurements led to a precise assessment of the Universe's age 13.5 billion years.

Currently, Freedman is using the *Spitzer Space Telescope* and telescopes in Chile to further refine measurements of the Hubble constant and establish more stringent constraints on the nature of dark energy.

Meanwhile, University of British Columbia (UBC) professor Catherine Louise Johnson was named to the American Geophysical Union's (AGU's) 2013 Class of Fellows, a prestigious award honouring researchers who have made exceptional contributions to Earth and space sciences. Johnson will be honoured as a 2013 Fellow in a ceremony on 2013 December 11 at AGU's Fall Meeting in San Francisco, California.

Johnson was nominated for her geophysical research covering planetary bodies from Mercury to Mars, including studying planetary magnetism, tectonics, and gravitational fields.

Johnson seeks to understand surface and satellite observations to determine the structure and evolution of planetary interiors, studying data sets that are returned by planetary missions and terrestrial volcanic rock samples that record the history of our own planet's magnetic field.

She is a co-investigator on both NASA's *InSight* mission that will place a single geophysical lander on Mars to study its deep interior, and on the *OSIRIS REx* mission that will map asteroid Bennu, and return a sample from its surface. As well, she is a Participating Scientist on the *Mercury MESSENGER* mission.

Johnson currently serves as a Professor of Geophysics in the Department of Earth, Ocean and Atmospheric Sciences at UBC and as a senior scientist at the Planetary Science Institute (Tucson, Arizona).

Earth and Moon seen from Saturn and Mercury vantage points

Mid-July was an extraordinary time for Earthlings. On the 19th, two distant NASA spacecraft took a picture of our planet, while people worldwide were invited to wave and smile as the photographs were taken.

MESSENGER, orbiting Mercury, captured the Earth and the Moon as a pair of bright star-like features. At the time of the photo, *MESSENGER* was 98 million kilometres from Earth. The spacecraft took the image as part of a campaign to search for natural satellites of Mercury, which is not known to have moons.

At the same time, *Cassini*, a spacecraft travelling within the Saturnian system, photographed the Earth and the Moon from a distance of nearly 1.5 billion kilometres. *Cassini* took advantage of a fortunate alignment of the Earth, Sun, and Saturn that placed the spacecraft in the shadow of Saturn while the Earth and Moon were visible across the rings. In the image, the Earth and Moon appear very large because they are overexposed,



Figure 4 — Two views of the Earth and Moon, from Mercury (left) and Saturn (right). The image from Mercury was photographed by *MESSENGER*, a spacecraft in orbit around the planet. The image from Saturn was captured by the *Cassini* spacecraft. The Earth and the Moon are seen through the diffuse E Ring of Saturn. Image: from *MESSENGER*, NASA/Johns Hopkins University Applied Physics Laboratory/Carnegie Institution of Washington; from *Cassini*, NASA/JPL-Caltech/Space Science Institute.

but in fact, each is less than a pixel in size. *Cassini's* images show the Earth as pale blue and the Moon a stark white, both visible between Saturn's rings. It's the first time the spacecraft's highest-resolution camera has captured Earth and its Moon as two distinct objects. In the image, the downward-pointing tails are artifacts caused by the image saturation.

The main science goal was to look at the more diffuse rings that encircle Saturn and to check for change over time. A previous mosaic in 2006 revealed that the dusty E-ring (fed by the water-ice plume of the moon Enceladus) had unexpectedly large variations in brightness and colour around its orbit.

NASA invited the public to celebrate by locating Saturn in their part of the sky and waving at the ringed planet. Much of the Americas, all of Europe and Africa, the Middle East, and much of Asia were visible when *Cassini* took the picture.

New robotic telescope LT2 to be double in size

The Astrophysics Research Institute of Liverpool John Moores University (LJMU) is planning to build a successor to the world's largest fully robotic telescope. The institute currently operates the Liverpool Telescope (LT), a 2-metre optical instrument located on La Palma, Canary Islands, which has been in operation since 2004. The new LT2 will be a 4-m-class facility, preferably located on La Palma as well.

The original LT has become a leading astronomical facility through its ability to react quickly to newly discovered or transient space events. More than 2000 schools have also used the robotic facility as part of an astronomy outreach program. LT2 also will be fully robotic and able to make rapid and flexible observations to follow up on discoveries made by other observatories.

According to a Royal Astronomical Society press release, productive talks have been held with the Instituto de Astrofísica de Canarias. Planners are hoping to work in partnership with the Island government to realize the project. La Palma, one of the best observing sites in the world, offers an obvious logistical benefit by locating LT2 at the same observatory as LT. The two telescopes may also be used together to provide an enhanced capability.

Transient science will be LT2's core mission. It will also be used for observations of binary systems and variable stars detected by the European Space Agency's *Gaia* mission, due for launch later this year. Exoplanets discovered by the next generation of space- and ground-based missions will also be possible targets. *

Andrew I. Oakes, a long-time Unattached Member of RASC, lives in Courtice, Ontario.

Madawaska Highlands Observatory Investment Opportunity¹

- 400% ROI > share buy back + dividends
- 15% annual dividends
- Limited time pre-build offer, \$0.50/share
- Own part of a premier destination

The Madawaska Highlands Observatory Corp. is offering an extra-ordinary opportunity to participate in this state-of-the art tourism facility. This pre-build offer is valid until Nov. 01, 2013. Open year round, the facility is destined to become a major tourism destination in Ontario and a key Canadian destination.

Natural night sky untouched by artificial light, 21.90 mag/arcsec², Milky Way makes a shadow
30" f/2.4 and 40" f/2.0 custom engineering dedicated visitors telescopes, no ladders
Premier Tourism destination in Ontario and an important Canadian destination
Hosting the two most powerful telescopes in Canada, including the 1-metre 5 sq. degrees WFT
State-of-the-art 25,000 sq. ft. Visitors Centre, with exhibits and displays and tours
80 min. from Ottawa, 2 hrs from Kingston, 2.5 hrs from the US and 3.5 hrs from the GTA/Mtl
8K state-of-the-art digital planetarium and separate HD lecture theatre
Off-grid energy independent building and up to LEED Platinum construction—zero carbon FP
K-12 educational destination to the 2 million students in Eastern Ontario and Western Québec
125,000 visitors expected in year 2 with up 25% of those international in origin
Major star festival with covered amphitheater and 4.5 star Hotel in Phase II

<http://madawaskahighlandsobservatory.com>
mho@madawaskahighlandsobservatory.com

1. This is a Private Share Offering. Return On Investment is 7 years, offer expires Nov. 1, 2013

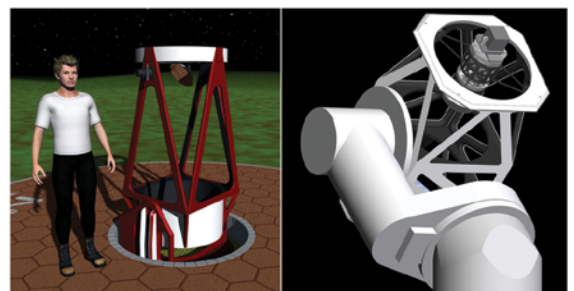

David Levy, Fireflies, and Arcturus Grace the London Centre

by Dale Armstrong, London Centre
(ngc4314z@yahoo.ca)

A run of dark and dreary skies brightened up on Sunday, June 9 to herald David Levy's arrival at the London Centre's Fingal Observatory complex. Wrapping up an eight-city tour of southern Ontario—one that included visits to Ottawa, Montreal, Kingston, Toronto, Kitchener-Waterloo, Mississauga, and Hamilton—David was the guest of honour at the annual "Steak and Stars" BBQ.

Centre members had worked overtime in order to have the observatory completed in time for the BBQ, and approximately

65 visitors were able to tour both Observatory One and the freshly completed Observatory Two during the event.

David Levy, long inspired by the astronomical references of the poet Gerard Manley Hopkins, took the crowd on an animated tour of early modern English literature. He highlighted Elizabethan and Jacobean references to celestial events—ones that he had uncovered while completing a recent doctorate at Hebrew University.

Unfortunately, immune to the call of English literature, the clouds moved in over the course of the evening, eliminating any chance for observing with the Centre's newest acquisition: a Celestron 14 EdgeHD, now perched on a very sturdy Byers Series II equatorial mount.

With the onset of darkness, those who had to work the next morning headed home, but David and a small group stuck it out, chatting amidst a different type of celestial allusion—a field of ever-variable fireflies. The fireflies demanded celestial reprise and, in due course, Arcturus heeded the call, putting in a brief appearance, and thus giving the festivities an astronomical capstone around 11:00 p.m. ★



Figure 1 — David Levy in action at London Centre.

David Levy Comes Home

by Randy Attwood, Mississauga Centre
(pastpresident@mississauga.rasc.ca)

Astronomy communicator, educator, observer, comet discoverer, and RASC member David Levy visited eight RASC centres—Ottawa, Montreal, Kingston, Toronto, Kitchener-Waterloo, Mississauga, Hamilton, and London—between May 31 and June 9 as part of a special lecture tour. Funding for the tour was provided by the Society's Public Speaker Program Fund.

Approximately 1350 people attended the lectures—many attending a RASC meeting for the first time. David's brother, Robert, attended the Toronto talk and stood with David on stage.

David spoke on his many experiences as a young astronomer growing up in Montreal, and the discovery of and fallout from Comet Shoemaker-Levy 9, which impacted Jupiter in July 1994. Many of David's fans were in attendance, some with cameras for that special photo, others with books to be autographed.

Thanks to the Trustees of the Public Speaker Program Fund (James Edgar, Hughes Lacombe, and Bruce McCurdy) and Executive Director Deborah Thompson, and to members along the tour who provided lodging, transportation, and meals. Lecture series such as this are a perfect way for the Society to achieve its mandate. Hopefully it will act as an example for similar lecture series in the future. ★



Figure 1 — David at the K-W Centre. From left: Al Douglas, David Levy, Rick Burke, Gerry Bissett (President, KW Centre), Robbie Henderson. Photo: Stephen Holmes.

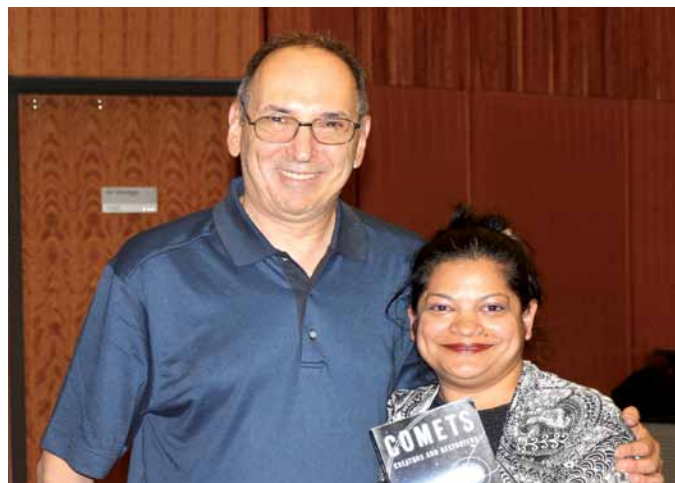

Figure 2 — David gets a hug from Toronto Centre member Sharmin Chowdhury. Photo: Randy Attwood.



Figure 3 — David at the Montréal Centre. From left to right (standing): Morrie Portnoff, Gary Smith, Carl Jorgensen, Alan Wright, David Brown, Pierre Paquette, Julien Dompierre, Richard Latulipe, David Levy, Ben Chu (George) Tang, visitor, Paul Simard, Constantine Papacosmas, Santiago Lopez, Detlev Schmalhaus. From left to right (kneeling): Patrice Scattolin, Frank Tomaras, Bill Strople. Photo: Frank Tomaras.

Figure 4 — At the Toronto Centre. Photo: Bill Longo.



Astronomers Kiss and Tell— Imperfections Revealed

by Richard J. Legault, Ottawa Centre
(richardjlegault@gmail.com)

Abstract

Yet another re-telling, for a popular audience, of the cultural history and physics underlying the well-tested science of astronomy.

Some Fantasy

This article is inspired by kissing. Mind you, it is not just your everyday, run-of-the-mill kissing. It is a peculiar kind of kissing. It is a kissing method that everyone who does serious observational astronomy practices, to one extent or another. This kind of kissing also happens to involve shapely curves that adorn some of the more unruly and less cooperative targets that astronomers make it their business to stalk and to observe—generally at night, in the dark, and from a distance. In keeping with their objectives to entice as many neophytes into their nocturnal pursuits as will take the bait, I will now re-tell a story of defects and imperfections too often only shared among the astronomically initiated. I must confess to not only being just such an enticed neophyte, but that, because of this story, I have had to abandon my naïve innocence, and I am now incurably infected. This is one of those stories that I think will never stop needing to be re-told.

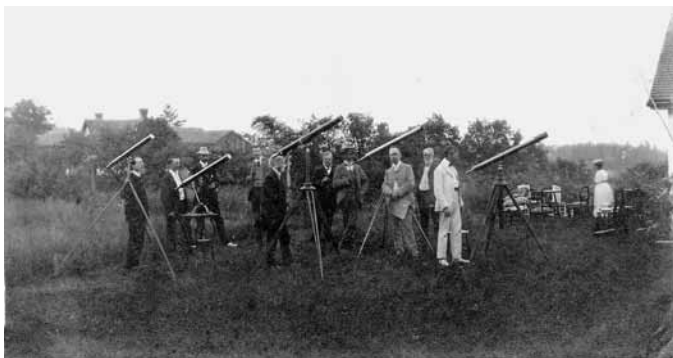

Figure 1 — Early star party. Image: RASC.

You often hear that that to be forewarned is to be forearmed. So if you are an amateur contemplating attending your first star party, it is best to know in advance that astronomers are not particularly well known for an ability to keep mum. Their method, let us admit it from the outset, is to kiss and tell. However, they don't just tell, they write. Moreover, they don't just write, they publish. And, don't get me started on all the drawings and pictures they circulate all over the place.

Let me tell you the story about my recent initiation. It is all about the universally practiced but rarely explained astronomical fantasy called *osculation*. This word is a polite euphemism, chosen perhaps to clothe a certain amount of fantasy and falsehood under a cloak of credibility that may be useful for a time but is never truly deserved for very long. It is a technical name derived from Latin; *osculating* quite literally means kissing. It is from the Latin diminutive *osculum*: little mouth or kiss. Before reading any further, be advised that what follows may offend the uninitiated who are unaccustomed to anxieties attendant on being coaxed outside their usual comfort zones. The material may be suitable neither for the timid of soul nor those whose complacency is easily offended by topics into which most people avoid probing too deeply.

By now you may be wondering whether you have mistakenly picked up a copy of some sordid little supermarket tabloid instead of your latest copy of the venerable *Journal of The Royal Astronomical Society of Canada* (JRASC). Let me assure you that all professional astronomers already know much of this story because I suspect that they, too, once found themselves abandoning a certain sense of innocent perfection with an experience not too different from my own.

My own initiation to the practice of osculation occurred only a few months ago after joining The Royal Astronomical Society of Canada (RASC) and receiving my very first member's copy of our *Observer's Handbook 2013* (Chapman 2012). Casually thumbing its pages, I chanced upon an arresting section on page 22 entitled "Principal Elements of the Solar System" with tables listing numerous bodies of the Solar System and a sampling of their physical and orbital properties. There were the main planets, some dwarf, and some minor ones, all listed with their mean distance from the Sun, the eccentricity and inclination of their paths, and a few other parameters that baffle those of us eager but dimmer-witted mere mortals who have yet to get a full taste of the finer subtleties of observational astronomy. My attention was drawn immediately to a section header, just crying out for attention with a fully capitalized bold-faced font: "**OSCULATING ORBITAL ELEMENTS FOR 2013.**" And then, just below in the text, came the simple explanatory sentence that first triggered the series of questions that would occupy my reading list for the next several weeks: "The given osculating elements can be used to determine an elliptical orbit that is a close approximation to the actual path of the body for times near the given epoch."

What was this all about? Why would the Handbook not provide

Figure 2 — Observer's Handbook 2013.

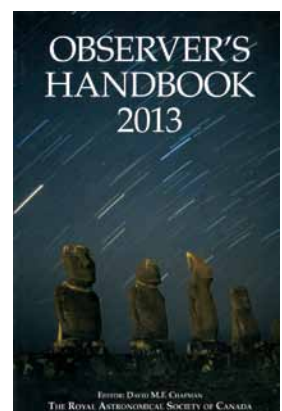

the actual orbital elements? Why would it only give the data for some close approximation instead of the real thing? What in the world was this *osculating* nonsense all about?

Little did I know that the answers to these questions would shatter to splinters my naïve understanding of the motions of celestial bodies. The disillusionment would remind me of the only other time I can remember coming close to a similar awakening. I was then maybe four or five years old and, snooping around in a forbidden closet, I happened to open an old suitcase. There to my surprise and delight were all the brightly wrapped Christmas presents, some with my name on them! My mind reeled as it dawned on me: “*No, Richard, there is no Santa Claus. They made it all up.*” I closed the suitcase quickly. I had to pretend for a long time that I did not know; otherwise, I would be condemned, without trial, of the crime of snooping where I had no business.

As I poked my nose deeper and deeper into the closets of history and the motivations that drive astronomers to the false pretensions of their osculatory fantasies, I would discover one of the best-kept open secrets rarely revealed and much less ever discussed with the astronomically uninitiated. And, I would hear the voice of my inner neophyte say, “*No Richard, there is no such thing as a perfect orbit. They made it all up.*” This time, however, being a serious grown-up, my first post-discovery reaction was that of the typically well-adjusted mature male ego: denial!

How could there be no such thing as perfect orbits? For heaven’s sake, this simply could not be. Everyone knows that planets go around in elliptical orbits. If you start counting at, say, the moment of Equinox, then exactly one tropical year later, the Earth will have completed exactly one orbit around the Sun and be exactly back at the same exact spot where you started counting a year earlier. Ditto for the Moon. Start at a moment of full Moon, count exactly one synodic month (29.530589 days) and you will be back to another full Moon, exactly where you started. Everybody knows this. These dates are on all the calendars. They are in the astronomy books. They are all over the Internet. They are calculated years, decades, even centuries in advance. Ditto for the planets and ditto for their moons, for eclipses, and for comets. The whole thing is like a big clock and it all just keeps ticking away with perfect regularity and repeatability forever and ever, amen. Right? Just go look it up and you will see.

Well, call me a natural-born skeptic, because something was amiss in all of this. So, I did look it up. And, I did see. And, I found out that everything I thought I knew was, as a matter of fact (gulp), all wrong!

Some Naked Truth

If you ask for an honest answer, astronomers today will tell you that there is no such thing in the Solar System as a celestial

body that repeatedly travels a mathematically predictable path that can be described as a perfectly elliptical orbit. They will tell you that, sooner or later, and without exception, all bodies in the Solar System will be observed to deviate from such perfectly predictable paths. When reading up on the predictability of orbital paths, I was quite prepared to concede that in the stupendously vast lifetime of a Solar System, say, in the tens of billions of years, then, okay, sure, all the bodies will deviate. However, nothing had prepared me for the fact that deviations happen whether you observe and count billions of trips around the Sun, *or just one*. Furthermore, this is true regardless of whether you use the models and theories of Ptolemy, Copernicus, Kepler, Newton, or Einstein. To pretend this is not so is a fantasy. It is an act of the imagination. The idea of a precisely predictable orbit is a fantasy exactly equivalent in kind to the idea of the Tooth Fairy. However, as we shall see, the elliptical orbit concept is a little bit more useful—at least to those of us who have made it past the stage of trading in our baby teeth. The reason this fantasy is useful is that astronomers are very, very good in their ability to kiss and tell, that is to say, to osculate.

Some History

In many lands, far, far away and long, long ago, before the age of science as we know it today, many different cultures invented many different fantasies to describe the motions we all can see in the sky. Many of these fantasies pervade our Western culture to this day. By 3500 BC, the Sumerians had found that their so-called Morning Star and Evening Star were in fact the single body we now call Venus. They chose to fantasize it as their fertility goddess Inanna. Her successor deities stretch out over the ages in an unbroken chain across the multi-generational collective Western imagination. From Ishtar in Babylon, Astarte in Phoenicia, Isis in Ptolemaic Egypt, Aphrodite in Greece, and finally to Venus in Rome, all took turns attaching their names and divine powers to our sister planet.

In Meso-America, the Mayans, who also independently discovered the Evening/Morning Star behaviour of Venus, made the planet one of their male war gods and used some of its repeating cycles to time raids and battles. Whether you prefer the celestial bestiary of the ancient Chinese, or our Western notions of the zodiac and the constellations, we all still rely, more often than we are ready to admit, on the usefulness of these ancient fantasies as memory aids to help us find our way to understanding what goes on up in the sky.

I think it is a serious mistake to dismiss the phantasmagorical concoctions of our ancestors as nothing more than the

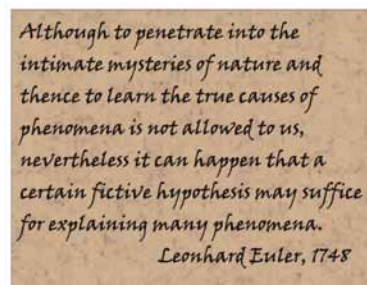



Figure 3 — Venus as a warrior deity from the Dresden Codex, Kingsborough version.

irrational delusions of naïve simpletons just barely evolved past the level of knuckle-dragging troglodytes. Quite the contrary, these concoctions were probably absolutely essential to the development of civilization itself. Whether or not the ancients truly understood the celestial connections, their livelihoods were much more critically dependent on many natural cycles driven by celestial motion. The organized feeding and fuelling of large densely settled populations would have been impossible without some level of appreciation of the celestially driven seasonality of agricultural cycles. This appreciation would have been absolutely essential to avoid badly timed activities that could lead to the dire life-and-death consequences of crop failures, famine, and social chaos. Consider also the boons available to those who literally followed the stars to navigate across large uncharted territories or bodies of water—to hunt or to harvest, to trade or to conquer. Regardless of how one imagined the forces driving the cycles of the seasons, tides, and weather, and regardless of the mythologies and deities invented to carry the experience and the wisdom across the generations, there can be no question. The greater the recognition of the regularities and motions up in the sky and their corresponding links to daily, monthly, and annual cycles down here, the better your chances of not merely surviving but to prosper and expand as a civilization. Make no mistake, fantasies are useful. To fantasize is one of the most critical and essential abilities we have. I would go so far as to say that without it, we would not only fail to be human, I doubt very much we could ever have become civilized.

Some Science

The idea of an orbit, as applied to motions up in the sky, dates back at least to the 3rd-century BC physics of Aristotle, and probably much earlier. The application of this idea in the 2nd century AD by Claudius Ptolemy was central to his writing one of the most important astronomy manuals to survive from antiquity: *The Almagest*. The Arabs, who preserved it for posterity through the Middle Ages, gave the work its title *Al-majisti* or *The Greatest* (work). Whatever else we may say about the Greeks of antiquity, we must admit they were among the first to develop a peculiar habit of mind that led them to sort things out into well-defined categories, into well-structured hierarchies, to set boundaries between things alike and things unlike. It is from this habit of mind that we inherited, for example, the notion of fundamental physical elements (*e.g.* Aristotle's Air, Water, Fire, Earth, and Ether or Quintessence), combinations and permutations of which were thought to produce all observable matter. This idea of classifying things according to properties (*e.g.* animal, vegetable, mineral), included some of the first serious attempts to make clear distinctions between the natural and the supernatural.

I like to think that it is perhaps because of this typically Greek quirk of mind that Claudius Ptolemy, in committing to text all that was understood about the heavens in his time, chose to make a clear distinction between what he must have regarded as two separate topics. Addressing celestial motions, he wrote what has come down to us as two separate works. First is *The Almagest*, which is essentially his “how-to” manual on how to understand and predict the natural motions in the sky. It is really a work of astronomy, pretty much as we would define the subject today. Secondly and quite separately, as a matter of a related, but distinct topic, he wrote *The Tetrabiblos* (*The Four Books*), a work on how celestial divinities exercise their powers on the Earth and how their signs may be read in the heavens. The second is really a book of astrology, or maybe even a sort of theology, also pretty much as we would define the subjects today. I'd have to conclude that Ptolemy, treating astrology with equal seriousness as astronomy and considering his other books, on geography, on optics, and on other subjects, would have to be considered more as something of a reporter or encyclopaedist of sorts, rather than anything we would call an experimental scientist. While I think it is clear he understood the ideas and methods he was writing about, the reputation today of his surviving work is more akin to an enterprise in collecting and writing down all that was known in his chosen topics and less like an undertaking to test its veracity (Moore 2002).

Some Giant Wing-Nuts

Nevertheless, the concept of an orbit, handed down from Aristotle and Ptolemy, held sway until the time of Copernicus in the 16th century. In his day, people had come to understand the original Aristotelian and Ptolemaic concept of the motions

of the heavens as a physical system that had a series of 40 to 50 nested crystalline spheres or orbs, called deferents, that enclosed the Earth. They saw the Earth as fixed and motionless inside the innermost orb. They thought of each of the five known planets and the Moon and Sun as stuck, like jewels, onto some of these see-through crystalline orbs, called epicycles. To oversimplify things somewhat, the complicated paths of the planets were understood as the simultaneous and perfectly circular revolution about the Earth of these perfectly spherical orbs nested within one another but each one a little bit off-centre. The physics and dynamics of the thing was that what really moved and turned around the Earth were the orbs. However, because these orbs were crystalline and transparent, all that astronomers could see of their motion was the *orbit* of the planet stuck onto them and being taken along for the ride, as it were. Ptolemy's complex geocentric model, with its crystalline orbs, deferents, epicycles, and eccentrics, was, as a matter of fact, quite good. Even the 16th-century heliocentric model of Copernicus at first could not do much better at predicting the positions of planets, until it was later improved by the geometry, mathematics, and physics of Kepler, Galileo, Newton, and Einstein.

After the heliocentric revolution of Copernicus, the next major step toward a science of orbital motion was taken by an obsessive-compulsive wing-nut known to the world as Johannes Kepler. We have it on the authority of no less an eminence than Stephen Hawking, the revered Lucasian Professor of Mathematics at Cambridge, that Kepler "was so obsessed with measurements that he even calculated his own gestational period to the minute—224 days, 9 hours, 53 minutes. (He had been born prematurely.)" (Hawking 2002). It was in 1605, Hawking continues, that Kepler announced the Law of Ellipses, "which held that the planets move in ellipses with the sun at one focus." Kepler published this "Law" later in 1609, along with his second law, the Law of Equal Areas, the famous sweeping out of equal areas in equal times, in his book *Astronomia Nova (New Astronomy)*. Now, in spite of the rhetorical grandeur of a word the likes of "Law," let me assure you that the paths of planets as astronomers know them today, or of any body, for that matter, gravitationally bound to a star with multiple planets, do not move in an ellipse with the Sun at one focus. The important idea here is that Kepler with his "Law of Ellipses" was the first astronomer/astrologer to abandon the Aristotelian perfection of spheres and circles. While this departure from circular perfection would later be demonstrated to be the most significant step forward in improving the predictability and periodicity of planetary motions in over 2000 years, the ellipse would also, as a matter of observable fact, eventually be shown to be imprecise. Accordingly, Kepler's work is often regarded as one of the finest and most significant cases of discarding a fantasy of perfection, based on challenging a historically authoritative theory found wanting against the tests of observation and evidence.



Figure 4 — Ptolemy's crystalline orbs from the *Harmonia Macrocosmica* of Andreas Cellarius.

What Hawking and modern astronomy still call Kepler's Law of Ellipses was an idea, a fantasy really, conjured up by an obsessive-compulsive personality. It was, however, a fantasy that he derived from carefully analyzed observational facts. Furthermore, this was a different kind of fantasy than the kind that had permeated astronomy from time immemorial. This was not merely a fantasy that Kepler based on recognition of a repetitive pattern of observed planetary motion, Mars in particular. More importantly, he and his followers could use his methods to test this fantasy against future observations and measurements. It was even more testable, because it made predictions. The very idea of a fantasy, not just any old fantasy, but a fantasy with which you can make predictions, predictions that are testable against observations in nature, the idea of an observationally testable fantasy is nothing less than the core technique of the scientific method as we know and use it today.

I happen also to think the idea of testability is fundamental to the motivation that joins us together as members of the RASC. I have to endorse the tradition to give the idea pride of place by stating in the very first sentence, on the very first page of our Handbook (Chapman 2012): The Royal Astronomical Society of Canada is dedicated to the advancement of astronomy and its related sciences; this Handbook espouses discoveries, and theories based on that *well-tested method* (my italics).

And as I slowly spiral-in on my topic of Kiss and Tell, I would say that it is with the kiss of scientific testability that fantasies become useful. As we will see, it is because of testability that we can tell. It is testability that enables us to tell when it is time to take mistaken ideas, too often accepted based on nothing more than authority and gullibility, and kiss them goodbye.

There can be no doubt, Johannes Kepler published many ideas we would have no hesitation today in calling wing-nutty. I am not only referring here to his success with his pseudo-scientific and more lucrative career as an astrologer. Even in his most serious work, he was obsessed with the mystical neo-Pythagorean ideas of the music of the spheres that he himself claimed to have pursued obsessively for 22 years (Kepler 1618), until he finally published his “discoveries” in 1618 in *Harmonice Mundi* (*Harmonies of the World*). The book is replete with such metaphorical mumbo-jumbo as:

I am free to give myself up to the sacred madness, I am free to taunt mortals with the frank confession that I am stealing the golden vessels of the Egyptians, in order to build of them a temple for my God, far from the territory of Egypt. If you pardon me, I shall rejoice; if you are enraged, I shall bear up. The die is cast, and I am writing the book – whether to be read by my contemporaries or by posterity matters not. Let it await its reader for a hundred years, if God Himself has been ready for His contemplator [presumably, Kepler himself] for six thousand years

—Kepler 1618, *Harmonice Mundi*, Book Five

Be that as it may, it is *Harmonice Mundi* that included Kepler’s Third Law of planetary motion, buried within a horribly incomprehensible mystical mish-mash of what Kepler’s

biographer, Max Caspar, described as a “cosmic vision woven out of science, poetry, philosophy, theology and mysticism” (Hawking 2002). This third law held that the cubes of the mean distances of the planets from the Sun are proportional to the squares of their periods of revolution. As it happened, this was the very idea, the core mathematical principle, that many regard as the source that inspired one of Kepler’s contemplators, a young Isaac Newton, not 100, but some 60 years later, to discover the gravitational “why” of the true motion of the planets. A more classic case of the usefulness of fantasies could hardly be quoted. Arthur Koestler cites the case of Kepler’s wing-nuttiness as one of the most bizarre in the history of human thought and as fine an example as can be had of remedial medicine for those who piously preach the faith that progress in science is governed by logic (Koestler 2010).

Before moving on, I need to explain that I have no desire to belittle or insult the memory of Kepler or of the quirks of character that fueled his obsession with measurement and his compulsive search for harmonious and mystical relationships among the planets. Far from it; I have nothing but admiration and can find no better words of praise than to agree with Hawking’s assessment. He places Kepler squarely among the scientific giants upon whose shoulders the rest of us can only hope to be allowed a perch to catch the merest glimpse of their vision. Furthermore, considering the value of Kepler’s discoveries



SkyShed POD MAX

**Now completing development
and launching shortly!**

- Rugged construction (Built like a tank) 5.5" thick walls
- 6' 4" high wall with 32" wide door and a deadbolt lock
- Most affordable medium-sized dome ever
- Easy to assemble
- Multi configurations with POD MAX Bays and Dome only option
- Manual control to remote control
- Electronics by Kendrick Astro Instruments
- Designed for astro photography, education, and research
- Perfect for schools, clubs, and individuals with large scopes
- Ships to your door
- Prices estimated at 4K – 10K depending on model and level of automation
- 12.5' dome with traditional slot design, 44" wide opening
- 20 degrees past zenith view



**Made in Canada for
world wide export**

For more information please visit:

www.skymedpodmax.com

Figure 5 — Kramgasse (grocer's lane) with Zytglogge clock tower, Bern, Switzerland, under which Einstein travelled while fantasizing a ride astride a light beam. Image: Wikipedia Commons, Daniel Schwen.



to those who followed, I think we must not only forgive Kepler his wing-nuttiness and his obsessions, but stand in awe and admiration of them.

I think we have to concede that the exceptional and rare kind of mind that is capable of taking leave of the accepted knowledge of its day and of spending so much of its most productive time in pursuit of a hunch, a fantastic new idea, or a hypothesis, is not a mind of the kind most of us would call normal. These days, we consider it a sin against political correctness to categorize people using stereotypes. Nevertheless, there is a certain amount of reality in the image we all recognize as the nutty-professor personality. This is why we can instantly identify and laugh without a moment's hesitation at the foibles of a Sheldon Cooper. This is also why, I think, modern biographers of some of the greatest scientific minds are much more prepared these days, to take some of these giants down a notch or two from their pedestals of historical reverence and tell us more about how strange and wing-nutty some of them could often be. No biographer of Einstein fails to note the daydreams and fantasies of the clerk at the Swiss patent office who liked to imagine how things might be if his bottom, mundanely parked in the seat of a Bern trolley car, were instead to be perched astride an electromagnetic beam riding along at the speed of light. We now know, for instance, that Sir Isaac Newton was privately obsessed with alchemy and the esoteric mysticism of prophetic numerology he thought lay between the lines in scripture. Many of his private manuscripts on these matters are now even available on-line. Even James Gleick revels in revealing to us how a young Richard Feynman took irresponsible delight during his Manhattan Project days in mastering the techniques of safe-cracking and secret codes (used to exchange innocent love letters with his wife) simply to aggravate and get even with the security goons and censors who made life miserable at Los Alamos (Gleick 1993). The nutty-professor stereotype is by no means modern and even has its precedents in antiquity. Arthur Koestler quotes Plato's famous poke at the astronomer Thales. Head in the heavens and contemplating the stars, he fell into a well, to be derided by a lovely Thracian servant-girl, as being so curious about the goings-on in the heavens, he was blind to what lay beneath his very feet (Koestler 2010).

Some Divine Perfection

Despite pagan precedents in Roman antiquity, it was not until after the appearance in 1687 of Newton's *Principia* and his mathematically rigorous concept of universal gravitation that the idea of the perfection of a clockwork cosmos really began to take hold in the imagination of Western intelligentsia. The idea has been hugely popular and promoted by the greatest cultural commentators, including Voltaire. The concept of a gravitationally bound Solar System functioning with the ideal precision of a well-oiled machine survives to this day, embedded in the very name we use for the science of its study: *celestial mechanics*. The phrase literally means machinery of the sky. Early in the 17th century, those of a more theological bent even touted this perceived mechanical perfection as the ideal proof of an existence of God, the Creator of the Universe. How, they asked, could such perfection of design come to be without the presence of a designer?

By 1802, the theologian William Paley published what has become probably the best known and best formulated rendition of the so-called "Argument from Design" in his *Natural Theology – or Evidence of the Existence and Attributes of the Deity Collected from the Appearances of Nature*. With great persuasiveness, Paley argued that if we compare the eye with a designed device such as a telescope, we must conclude that "there is precisely the same proof that the eye was made for vision, as there is that the telescope was made for assisting it" (Dawkins 1986). With even greater relevance to the clockwork cosmos concept, Paley asked us to consider a lost pocket watch stumbled upon in crossing the wilderness of a heath. With iron-clad logic, he reasoned that even if we could never discover how that particular watch had come to be found in that particular place, we would have to conclude, by virtue of its precision and intricacy of design, "that the watch must have had a maker: that there must have existed at some time, and at some place or other, an artificer or artificers, who formed it for

the purpose which we find it to actually answer; who comprehended its construction, and designed its use.” It is by insisting on the necessity of this conclusion that Paley repudiates the position of the atheist who, in order to deny this argument, must also deny reason itself because precisely “every indication of contrivance, every manifestation of design, which existed in the watch, exists in the works of nature.”

Paley put the case of the perfection of nature as the signature of design, so forcefully well, that as recently as 1986 the Oxford biologist Richard Dawkins was still finding it necessary to publish for lay audiences a series of rebuttals of it. Since that time, Dawkins has continued into the 21st century to wage nothing less than a sustained campaign against the concept of intelligent design and a created Universe. Dawkins’s opening salvo was, of course, his very popular book *The Blind Watchmaker*, touted in the popular press to be “as readable and vigorous a defense of Darwinism as has been published since 1859 (The Economist 1986).”

We often forget that Dawkins was, after all, up against some very powerful opposition. Newton himself, the father of

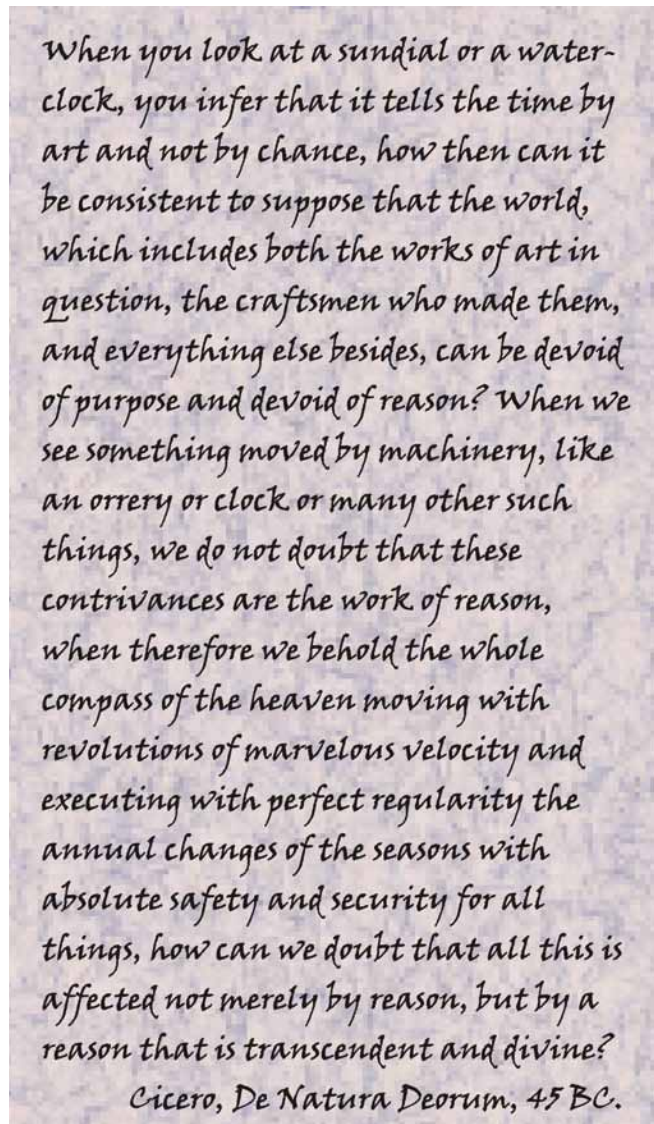

*When you look at a sundial or a water-clock, you infer that it tells the time by art and not by chance, how then can it be consistent to suppose that the world, which includes both the works of art in question, the craftsmen who made them, and everything else besides, can be devoid of purpose and devoid of reason? When we see something moved by machinery, like an orrery or clock or many other such things, we do not doubt that these contrivances are the work of reason, when therefore we behold the whole compass of the heaven moving with revolutions of marvelous velocity and executing with perfect regularity the annual changes of the seasons with absolute safety and security for all things, how can we doubt that all this is affected not merely by reason, but by a reason that is transcendent and divine?
Cicero, De Natura Deorum, 45 BC.*

modern physics, publicly sides, right in the *Principia*, with the deists: “This most beautiful system of the sun, planets, and comets, could only proceed from the counsel and dominion of an intelligent and powerful Being (Newton *Principia* 1687).” Nevertheless, I am not entirely sure why biologists get so fixated on needing to defend Darwinism, any more than, say, physicists do electrodynamics or geologists, plate tectonics. Nor am I entirely sure the good professor made as good a showing of himself as he might have. *The Blind Watchmaker* argues that an equivalent level of divine perfection and apparent design in biology can be achieved naturally via evolution by cumulative natural selection and without appeal to the idea of a creator god. I think it is a mistake of the first order to agree with the idea that Nature ever achieves anything that ever approaches a state of perfection.

While Newton was a confirmed deist, he took a much different view of the idea of perfection. He found it sorely lacking in the Solar System. In spite of the predictive power and accuracy of his mathematical principles and physical laws, he found there was yet a substantial and unsolvable residual of imperfection in the orbital motions he described. Some authors I was reading went so far as to say that Newton made no bones about leaving to Providence the need of actually having to physically intervene from time to time to correct the orbital trajectories that Newton saw would otherwise, left on their own, degenerate to chaos and possibly catastrophe (Peterson 1993). From the revered scientific reputation of Newton, I would never have imagined in a million years that he would ever have expressed such a view. Being a natural born skeptic, I looked it up. I found the relevant passage in Querie 31 of Newton’s *Opticks*:

*Now by the help of these Principles, all material Things seem to have been composed of the hard and solid Particles above-mention’d, variously associated in the first Creation by the Counsel of an intelligent Agent. For it became him who created them to set them in order. And if he did so, it’s unphilosophical to seek for any other Origin of the World, or to pretend that it might arise out of a Chaos by the mere Laws of Nature; though being once form’d, it may continue by those Laws for many Ages. For while Comets move in very excentrick Orbs in all manner of Positions, blind Fate could never make all the Planets move one and the same way in Orbs concentrick, some inconsiderable Irregularities excepted, which may have risen from the mutual Actions of Comets and Planets upon one another, and which will be apt to increase, till this System wants a Reformation.”
(Newton 1730, my emphasis).*

While it may be presumptuous to consider an Oxford scholar of the stature of Professor Dawkins to be in want of advice from the likes of me, I do think he chose the wrong argument. He could have argued a much better case by simply pointing out the dire imperfections with which natural selection is often found to really mess things up. My own body, a paragon of messy imperfection, is as good an example as any. As Dawkins

and Darwinism would have it, my upright posture is inherited, from ancestors who came down from the trees to make a living on the open African savanna. It is an evolutionary legacy that has left many of my body parts way out of sync from many others that are anything but perfectly adapted to an upright posture. From the pain in the nether parts of my gravity-compressed vertebrae, to the throbbing of my un-strategically located sciatic nerve, to the weaknesses of the hernia-prone and surgery-repaired muscles of my abdominal wall, it would be hard to argue that these problems, all aggravated by an upright posture, are properties of anything that could be called even close to perfection. And, as I now find myself on the wrong side of the threshold of geezerhood, don't get me started on my blurring vision, hearing loss, cross-wired reflexes, and increasingly befuddled memory. If these are characteristics I share with a Lord God in whose image I am blessed to have been created, I'd have to feel as sorry for the Old Fella as I'm beginning to do for myself. Now I understand why He was so grumpy all the time! However, I am not sure I'll ever understand why Dawkins gets so cantankerous with the creationists. Maybe he feels his geezerhood coming too.

I think Dawkins could have done substantially better taking on the Creationists and their argument from the perfection of design, had it occurred to him to consult any competent astronomer. Most of the ones I know are quite prepared to admit that if their science teaches anything, it is the observable fact that there is no such thing as perfection in Nature. Quite the contrary, Nature is messy. If the history of astronomy teaches anything, it is that numerous fantasies of perfection have had to be tossed out, one after the other, in order to answer to the tests of the real observed motions in the sky: the perfection of the crystalline orbs, the perfection of the circles, the perfection of ellipses, and the list goes on. Perfection, whether you look up there or look down here, is a fantasy.

If Nature is anything, it is messy. In the immortal bumper-sticker teaching of *Forrest Gump*, "Shit happens!" (Zemeckis 1994)." Astronomers, however, have much better manners and use much more polite phrases. They teach, "Perturbations happen!"

And so, if astronomers have long ago discarded the idea of the perfection of orbits, I think it is high time to sweep away the cultural clutter of a Solar System imagined to work with the perfect predictability of a mechanical clock. A much better image would be one of a dance floor on which the participants waltz together, performing the same patterns of moves again and again, but never quite stepping exactly in their previous footprints. As we visualize ourselves in gazing down from the mezzanine, as it were, overlooking the romantic elegance of the waltz below, let us finally spiral in on the key idea that perturbs astronomers, driving them to Kiss and Tell.

Osculating Orbits Revealed

Modern astronomy recognizes that the trajectories of planets in our Solar System are very close to, but by no means perfect

ellipses. As we saw above, even Newton never really fully subscribed to the idea of perfection. He saw that, if his laws of motion and universal gravitation worked as he described them and as he calculated their consequences, there are simply so many ongoing and periodically recurring mutual gravitational effects—perturbations—between the planets, that their paths are continuously distorted from ever settling down to perfect ellipses. Though many of these effects are tiny, many are also cumulative. Accordingly, their effects are not always immediately apparent and not too relevant to observational astronomy over relatively short periods of time—a few months, or years, or even a lifetime. However, over longer timescales, because some effects are cumulative, they do make a significant difference. This is why documents used for observational astronomy—almanacs, tables of orbital elements, and our *Observer's Handbook*, for example—all need updating from time to time to reduce error margins that tend to grow over time as all orbital trajectories in the Solar System unceasingly evolve.

Mutual gravitational effects between planets and other bodies in the Solar System give rise to ongoing changes to every single one of the standard parameters astronomers use to define the shape, orientation, and velocity of a body's orbital motion and to predict its position at any given moment in time. As matter of observational fact, the orbital trajectories of Solar System bodies never settle down to a steady state. The shapes, orientations, and speeds of these trajectories are undergoing continuous change. Our Handbook, for example, notes that the size and period of revolution of the Moon's orbit around the Earth is currently steadily increasing. This is because gravitationally driven tidal effects constantly work to transfer kinetic energy and angular momentum between Earth and Moon. The effects of this transfer are small. Nevertheless, the Moon is slowly but surely receding from the Earth by 3.8 centimetres per year and the Earth's spin period (our day) is slowing down by 1 second every 40,000 years (Chapman 2012).

Another good and more general example of the imperfection and ongoing change of orbital trajectories is the rotation of the line of apsides—the imaginary line that connects the two "pointy" ends of an ellipse and defines its major axis. The rotation of the line of apsides of an orbital trajectory happens because of the continuous mutual gravitational effects between all the masses of all the bodies in the Solar System. Sometimes we more generally call this kind of motion *apsidal precession*. It continuously changes the orientation in space of an ellipse-like orbit. It prevents the trajectory from ever following a true closed-curve ellipse. When referring to Earth specifically, the motion is formally called precession of the ecliptic and amounts to an observed rotation of the ecliptic plane of 11.45 seconds of arc per year (Fitzpatrick 2013) or a full 360-degree rotation in about 113,188 years insert (see Figure 6). When added to the much larger effect of axial precession, the two produce the effect once known as precession of the equinoxes, that since 2006 the IAU has recommended be officially called General Precession. Apsidal precession is much faster for the

Moon. Roy Bishop, longtime RASC member and former Handbook editor, estimates “the major axis of the lunar orbit rotates prograde with a period of 8.85 years” (Chapman 2012) or about 40.678 degrees per year.

Apsidal Precession				
Planet	arc sec/year		Period of Precession -Years	
	Observed	Theoretical	Observed	Theoretical
Mercury	5.75	5.50	225,391.30	235,636.36
Venus	2.04	10.75	635,294.12	120,558.14
Earth	11.45	11.87	113,187.77	109,182.81
Mars	16.28	17.60	79,606.88	73,636.36
Jupiter	6.55	7.42	197,862.60	174,663.07
Saturn	19.50	18.36	66,461.54	70,588.24
Uranus	3.34	2.72	388,023.95	476,470.59
Neptune	0.36	0.65	3,600,000.00	1,933,846.15

Figure 6 – The observed and theoretical rates and periods of apsidal precession of the planets. Periods are calculated from Fitzpatrick’s rate data. Adapted from Fitzpatrick 2013.

The topic of apsidal precession, in general, is a good one to help illustrate the need for the mathematical fantasy of an osculating orbit, as used by astronomers. As illustrated in Figure 7, the ongoing trajectory of any gravitationally bound body in the Solar System is subject to continuous distortion and re-orientation from what, under the ideal theory of a simplified two-body problem, would become a perfect ellipse whose line of apsides would remain perfectly still. The orbit could even become a circle whose line of apsides would disappear altogether. In the messy reality of a multi-planet Solar System, ongoing gravitational effects causing apsidal precession prevent this perfect ellipse or circle from ever forming. The shapes of real planetary trajectories are only ellipse-like and in fact never even form true closed curves. The pseudo-ellipse shapes of real planetary trajectories are in fact continuously pivoting shapes in motion about the pseudo-focus represented by the centre of gravity of the system. After over 325 years of continuous trying, astronomers, physicists, and mathematicians have yet to come up with a perfect mathematical procedure that can predict exactly where a planet in an n-body Solar System will be or what the exact shape of its orbital trajectory will be at any moment in time. There are many procedures with good solutions for special restricted cases. There are also many good approximate solutions for the general case, but they all lose precision and accuracy and produce ever-greater errors the farther backward or forward in time one wishes to go.

The practical approach used by observational astronomers is to choose a moment in time and a mathematically defined curve (not always an ellipse) the shape of which best fits the real orbital trajectory for that moment. Best fit is the shape

that reduces the observational errors between the real trajectory and the chosen curve to an acceptable degree of precision for a slice of time around the chosen moment. Such a best-fit curve, because it will touch or *kiss* the real curve of the trajectory in several points, is called an *osculating orbit*. From these most-shapely and kissing curves, astronomers are able to divine a lot. The mathematics are now so good that, from these osculating orbits, astronomers can tell you the position in the sky of all the larger Solar System bodies to within one or two seconds of arc for any moment close enough to the chosen date (called an epoch) that defines the osculating orbit. The osculating orbit and other techniques are so good that astronomers can predict Solar System events to the minute, years, decades, even centuries in advance: equinoxes, solstices, perihelia, apohelia, eclipses, occultations, transits, returns of periodic comets, and so on. As the real orbital trajectories continue to evolve over time and the accuracy of the osculating orbital elements for a given date degrades and fails to achieve the required degree of precision, different osculating orbits calculated for the relevant dates may be used. Even greater accuracy, as might be required, say, for a space vehicle to make a high precision sequence of fly-bys of several planets and their moons, can be achieved using these and other approximating techniques.

It is important to note that there are other phenomena besides gravitational perturbations between the orbiting masses of the Solar System that also affect changes to orbital elements. Examples include oblateness of the Sun, relativistic effects, atmospheric drag, radiation pressure, and electromagnetic forces. It is also important to note that it is not only the orbital parameters of spin, semi-major axis length, and line of apsides orientation that are subject to ongoing perturba-

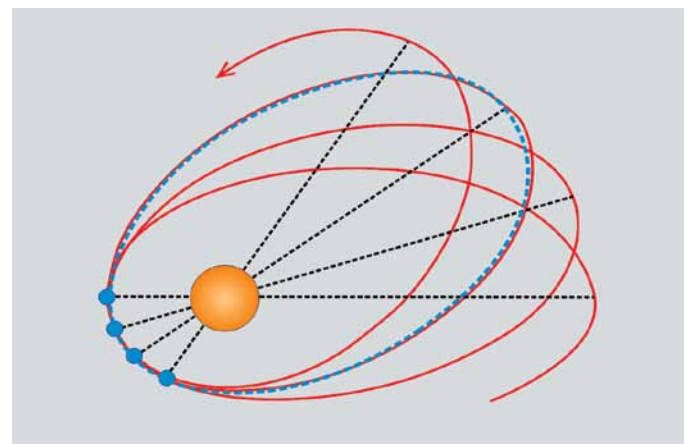

Figure 7 – Line of apsides (black dotted line) of an orbital trajectory (red line) pivots about the focus over long time periods, changing the orientation in space of the whole orbit. The orbit never truly achieves the shape of a perfect and closed ellipse. An osculating orbit (blue dashed line), is a mathematically ideal curve that closely fits the actual orbit for a limited time. This ideal curve touches or kisses the actual orbit at several points, hence the term osculating orbit.

tions and distortions. All orbital parameters are affected. A good example for orbital eccentricity and inclination comes from findings in very long-term Solar System-simulation models calculated on super-computers using the mathematical technique of numerical integration of differential equations. Jacques Laskar and his colleagues at the Bureau des longitudes in France have made major contributions in this domain in recent years. For example, as shown in Figure 8, they have run models simulating billions of years of Solar System evolution both backwards and forwards in time. They have found very large variations of orbital eccentricity and inclination, especially of the inner planets that, because of their smaller mass, are subject to significant gravitational perturbation by the much more massive and more stable outer planets—especially Jupiter.

More Imperfections and More Testing

You might think that the imperfections and departures from the behaviour of perfect Keplerian elliptical orbits are something that causes no end of grief and lamentation among astronomers. Nothing could be further from the truth. Since the time of Kepler and Newton, it is in fact through the study of these imperfections that astronomy has moved forward with many major discoveries, including finding new planets, not just in our Solar System, but also around other stars. They have also improved the study of physics itself. It is precisely by the method of studying Nature to identify imperfections, anomalies, and deviations from theory that we conduct the all-important tests to confirm or falsify hypotheses and theories from which the sciences advance.

A classic case that tested Newton's law of universal gravitation is the example of the work of Urbain Le Verrier in Paris and John Couch Adams in Cambridge in 1845. Independently of each other and following Newton, they worked on hunches that the significant difference between observed and theoretical motion of Uranus might be an indicator of gravitational perturbation of its orbit by an as-yet undiscovered significant planetary mass. At the time, it was by no means clear whether such a mass existed or if, alternatively, the theory was wrong. Theoretical calculations indicated that if such a mass did exist, it ought to be in a particular region of the sky at a particular time. Sure enough, a search in the places and times predicted by some of the calculations led to the discovery in 1846 by Johann Gottfried Galle at the Berlin Observatory of the planet we now call Neptune (Kent 2011). While the historians still argue the facts and report that the calculations were terribly flawed, as the story goes, credit for discovering a planet with nothing but the point of a pen, and the privilege of naming it, was nevertheless given to Le Verrier. His prediction was reportedly within less than one degree of longitude of the actual observed position!

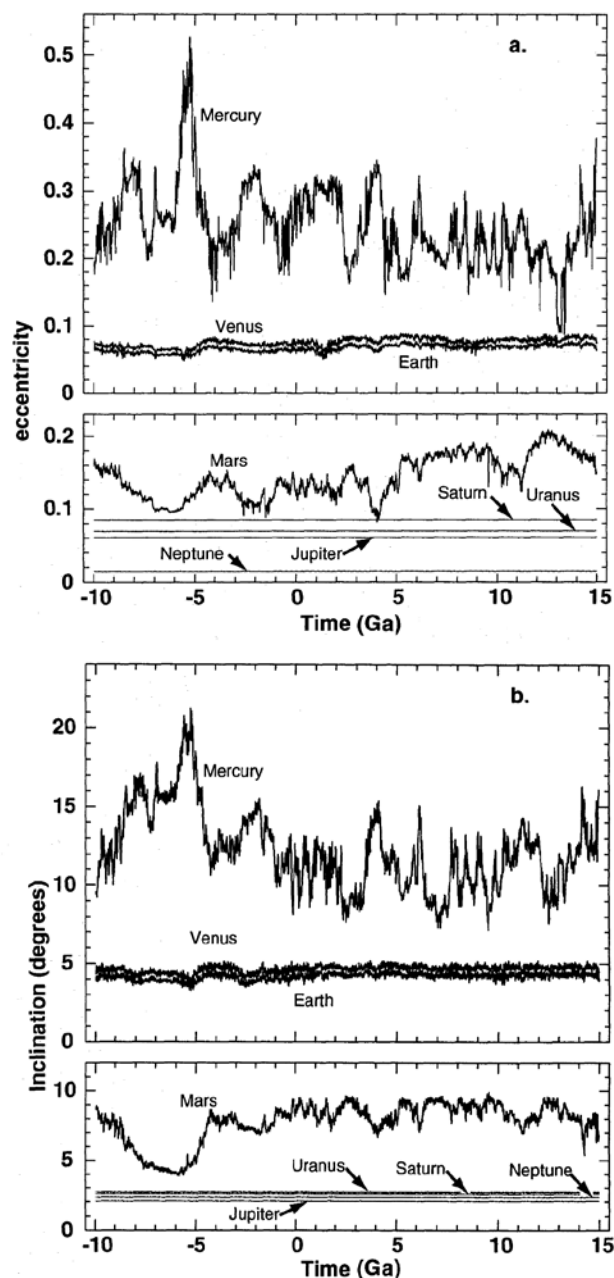

Figure 8 — Numerical solution of the average equations of motion of the Solar System 10 Ga (billion years) backward and 15 Ga forward. For each planet, the maximum value obtained over 10 Ma (million years) for eccentricity (a) and inclination (b) from the fixed ecliptic are plotted versus time. (Laskar 1994).

An even more famous example of the use of astronomical anomalies for the testing of scientific theories is the case of the apsidal precession of Mercury. Interestingly, this case also involved the Paris astronomer Urbain Le Verrier, who in 1859 calculated that the observed rate of apsidal precession of Mercury was off by some 38 seconds of arc per tropical century from what Newton's theory predicted. He derived his observed rate from the best data available at the time, taken from records of timed observations of transits of Mercury over the Sun's disk from 1697 to 1848. To the skeptical Le Verrier

and those who understood his results, this discrepancy revealed a definite issue: either the records and observations were wrong, or Newton's celestial mechanics were in want of serious reconsideration. Later and better observation and re-calculation showed the discrepancy was even larger: 43 arcseconds per tropical century. Numerous attempts at resolving the anomaly were made by many, but they all created more problems than they fixed—a situation, as it were, of the medicine being worse than the disease.

The solution to the case had to wait until the early 20th century for an outrageous and courageous proposal that wanted literally to do away with three more fantasies of perfection: Euclidean geometry, rectilinear Cartesian space, and Newtonian uniform flow of time. To resolve the discrepancy, an upstart young physicist proposed the idea that gravity is mediated by the effect of mass, not on forces and motions, but on the curvature of the space-time continuum. It was Albert Einstein who proposed a resolution to the discrepancy in this way in 1916 as one of three tests that scientists could use to validate his theory of general relativity. Science kissed goodbye to three more fantasies of perfection as the results of the testing went down into the history of physics as a stunning success (Fitzpatrick 2011, Peterson 1993).

Neither physics nor astronomy has ever been quite the same since. From a cultural point of view, and borrowing a terrible metaphor from paleontology, you could say it was a time in academia of “punctuated equilibrium” (Eldredge and Gould 1972). Yes, it was all most perturbing. Nevertheless, as physics mutated, astronomy adapted, and science evolved. Looking back, it all seems rather biological, does it not? Alas, I am not sure the biologists even noticed. Maybe they were too busy sniping at creationists. Sometimes I wish they could all just kiss and make up.

A Concluding Reminder

So there you have it. That is my story and I am sticking to it. Next time the clouds move in to perturb the perfection of your star party, try not to get too testy. Take aside the nearest neophyte and let the storytelling start. Feel free to re-tell all about the fantasies and imperfections of astronomers who kiss and tell. You can even hand out some copies of JRASC and show them all the pictures.

Just remember, even if storytelling lacks perfection, it is, nevertheless, a very well-tested method.

Acknowledgements

My thanks to David Chapman for having the good sense to send me to the library and to Jim Robar for sending me to Koestler.

References

- Cicero, Marcus Tullius (45 BC). *De Natura Deorum*, translated by H. Rackham (1967). Cambridge, Massachusetts: Harvard University Press. Available at: <http://archive.org/details/denaturadeorumac-00ciceuoft>
- Chapman, David M.F. (Ed.) (2012). *Observer's Handbook 2013*. Toronto: Royal Astronomical Society of Canada.
- Dawkins, Richard (1986). *The Blind Watchmaker: Why the Evidence of Evolution Reveals a Universe without Design*. New York, NY: W.W. Norton & Company.
- Eldredge, Niles & Gould, S.J. (1972) Punctuated equilibria: an alternative to phyletic gradualism. In T.J.M. Schopf (Ed.), *Models in Paleobiology*. San Francisco: Freeman. Reprinted in Eldredge, N. (1985) *Time frames*. Princeton: Princeton Univ. Press.
- Euler, Leonhard (1748) *Introductio in analysin infinitorum (Introduction to the Analysis of the Infinite)*, Blanton D.J. (Trans.) (1988). Neu-Isenburg: Springer.
- Fitzpatrick, Richard (2013) *Newtonian Dynamics*. Available at <http://farside.ph.utexas.edu/teaching/336k/Newton/node115.html>, retrieved 2013 April 2.
- Gleick, James (1993) *Genius: The Life and Science of Richard Feynman*. New York: Random House.
- Hawking, Stephen (2002). *On the Shoulders of Giants—The Great Works of Physics and Astronomy*. Philadelphia and London: Running Press.
- Kent, Deborah (2011). The Curious Aftermath of Neptune's Discovery. *Physics Today*, 64, 12. Available at <http://dx.doi.org/10.1063/PT.3.1363>.
- Kepler, Johannes (1618) *Harmonies of the World, Book Five*, in Hawking (2002).
- Koestler, Arthur (2010) *Les Somnambules – Essais sur l'histoire des conceptions de l'univers*, Georges Fradier, translator. Paris : Les Belles Lettres.
- Laskar, Jacques (1994). Large scale chaos in the Solar System. *Astronomy and Astrophysics*, 287, L9-L12.
- Moore, Patrick (2002). *Venus*. London: Cassell Illustrated.
- Newton, Isaac (1687). *The Mathematical Principles of Natural Philosophy*, in Hawking (2002).
- Newton, Isaac (1730). *Opticks or, a Treatise of the Reflections, Refractions, Inflections, and Colours of Light, Fourth Edition, corrected*. Project Gutenberg EBook available at www.gutenberg.org/3/3/5/0/33504/2010, retrieved 2013 May 14.
- Peterson, Ivars (1993). *Newton's Clock – Chaos in the Solar System*. New York: W.H. Freeman and Company.
- Vail, Gabrielle & Hernández, Christine (2011). *The Maya Codices Database, Version 4.0*. Available at www.mayacodices.org.
- Zemeckis, Robert (Director) (1994). *Forrest Gump*, screenplay by Eric Roth, based on the novel by Winston Groom, Paramount Pictures, Hollywood, California.

What to Do When the Astrologer Crashes Your Star Party: Strategies for Making Friends and Influencing Enemies

by R.A. Rosenfeld, RASC Archivist
(randall.rosenfeld@utoronto.ca)

During the 2009 International Year of Astronomy (IYA) celebrating humanity's cumulative celestial discoveries, many astronomers turned their eyes to the skies, not only to encourage fellow citizens to do likewise, but also to roll them in heavenwards exasperation at the growth of yet another of popular culture's seemingly endless succession of cosmically dire distortions of things astronomical. It was not a little ironic that the fourth centenary of Galileo's discovery of the Medicean stars, the birth of telescopic astronomy, marked as well the beginning of the pop culture supernova stage of the so-called "Mayan" Prophecy, also known in the literature as the 2012 phenomenon. The pop culture Mayan Prophecy was an impressive example of cultural misappropriation, abuse of the archaeoastronomical record, and entrepreneurial ambition. Even if a significant epoch in the historic Mesoamerican Long-Count calendar was winding down, a passing acquaintance with human styles of time and cultures of chronology ought to have suggested that the end of a measure of time means nothing but the end of a particular measure of time, yet many astronomy educators found themselves having to reassure the public that their world would not end on 2012 December 21 from the death throes of an expiring calendrical period.

There is no need here to further discuss the specifics of the millenarian—that is, end of the world—pretensions of the 2012 phenomenon, for they have been expertly exposed by Dr. Edward Krupp (2009, 2013), Prof. Anthony Aveni (2009), and Prof. Mark van Stone (2010), among others.¹ That delusion has flourished and faded, and will be succeeded in turn by the next affront to the spirit of measured inquiry. We have been here before, we will be here again. The subject of this paper is a different class of potential threat to the effectiveness of astronomy education and public outreach (EPO), when the rational encounters the well-prepared irrational in the public sphere.

It's wickedly hard work unmasking astronomical myths masquerading as science, what popular astronomy blogger Phil Plait calls "bad astronomy." Whether confected by shrewd charlatans, or the artlessly credulous, or by aberrant accident, any irrational account may become a many-headed hydra broadcast by the media, packaged by the popular entertainment industry, and marketed by the pay-per-service spiritual enlightenment sector. The RASC and its partners, "dedicated to the promotion of astronomy and allied sciences," ought to play a role in curating the scientific integrity of public discourse as a component of meaningful education and public

outreach. To deny the obligation and dodge the role is to court irrelevance in the public sphere. As it is, we already pull considerably less weight in that arena than many a reality-TV nonentity (take your pick).

In the normal course of things, dealing with space junk like the Mayan Prophecy is a fairly straightforward if tiring business. Most people are probably grateful to become better informed through the agency of their friendly local astronomer. There are times, however, when attempting to be astronomically useful to fellow citizens is made much more difficult by a particular circumstance. Those who have ever suddenly had to face off with a self-professed astrologer who is not only vigorous and vocal, but who is seemingly well-informed about both the current practice of astronomy *and* the pre-19th-century filiation between astronomy and astrology will know just how easily an EPO effort can be side-railed. Astronomy educators haven't lived until they've had the experience of their message side-tracked, their knowledge and understanding questioned, and their audience's sympathies alienated. Think it can't happen to you? Think again. The threat is not from garden-variety hawkers of mass daily horoscopes but rather from those more adept, disquieting, and inimical. The goal of this paper is to alert those who do astronomy EPO to the risk posed by the astronomically adroit proselytising astrologer in the audience, and to suggest some strategies to effectively neutralize that risk and emerge with your science message unimpaired.

A well-known text from the Warring State Period of Chinese history (476-221 BC) advises:

"If you know the enemy and know yourself, you need not fear the result of any battles. If you know yourself but not your enemy, for every victory gained you will also suffer defeat. If you know neither the enemy nor yourself, you will succumb in every battle". (Sūnzǐ 1910, 24-25)

Who, then, is this enemy?

The astrologer you have to worry about is someone with advanced training and qualifications in the mathematical and physical sciences. Sound like an impossible contradiction? It should be, but it is also a reality. This writer knows of several people with advanced degrees from very prestigious institutions in computer science, physics, mathematics, the life sciences, and the history of science who identify themselves as "astrologers." In practical terms, that means they can read the professional astrophysical literature with a scientist's understanding beyond the capabilities of most amateur astronomers. How many of the readers of this article have mastered the mathematical bases of string theory, celestial dynamics, or the modelling of galactic mergers? How would you fare in debate with an opponent set on convincing your audience of the relevance of astrology, an opponent whose understanding of modern astronomy is more profound than yours? Unsettling is hardly the word for it.

Want some examples? *Astrodiens* is one of many companies that specialize in designing high-accuracy programs using Jet Propulsion Laboratory (JPL) parameters, which—for a fee—are used to provide their personal and business clients with bespoke horoscopes. *Astrodiens's Swiss Ephemeris* software is one of the better known of such products. It is built on the Jet Propulsion Laboratory Development Ephemeris 406 (JPL DE406), a program formulated in the main for space navigation and astronomy; its writers certainly didn't create it as the basis for a commercial "astrology" application—but such is the risk in being decent about allowing free and open distribution of scientific programs! One of *Astrodiens's* current principals is Dr. Alois Triendl, who claims to hold a Ph.D. in physics from ETH Zürich (I have been unable to verify this). Yes, you read it right, that ETH—the *Eidgenössische Technische Hochschule Zürich*, from which Albert Einstein received his diploma in 1900 and where he served as Professor of Theoretical Physics from 1912 to 1914. The other is Dr. Liz Greene, who has a terminal Ph.D. (legitimate) in a rather less surprising area, awarded for a thesis (2010) on *The Kabbalah in British Occultism 1860–1940* from the Department of History of the University of Bristol. Then there's Kepler College in Washington State, the "premier" institution for training astrologers in the United States, on whose staff are Dr. Lee Lehman, with a Ph.D. in botany from Rutgers, and Dr. Bruce Scofield, with a doctorate in the History of Science from the University of Massachusetts. Dr. Nick Campion has been associated with that college, although his main appointment is as Director of the Sophia Centre for the Study of Cosmology and Culture at the University of Wales Trinity Saint David.² His doctorate is from the University of the West of England. Dr. Nick Kollerstrom, an expert on Newton's lunar theory (Kollerstrom 2000), was until 2008 an honorary research fellow in Science and Technology Studies at University College, London. Kollerstrom, beyond his work on the history of complex celestial mechanics, did valuable work on the history of the discovery of Neptune (*e.g.* Kollerstrom 2006), yet he was also the BBC's lunar gardening correspondent, and author of *Gardening and Planting by the Moon* (Kollerstrom 2012), and *The Eureka Effect: Astrology of Scientific Discovery* (Kollerstrom & O'Neill 1996).³ I could multiply example on example, but this should give you a sufficient taste of the problem. It is one I view with considerable distaste.

What happens in debate, when the astrologer affirms that the very foundation figures of astronomy were astrologers? That the greatest mathematical astronomer of Greco-Roman Antiquity, Ptolemy, author of the *Almagest* (*ca.* AD 150), also wrote the astrological *Tetrabiblos* (Ptolemaeus 1998)? That Copernicus (1473–1543) studied astrology when he read medicine at Padua (1501–1503; Westman 2011, 104–105), and that Georg Rheticus (1514–1574), Copernicus's disciple and the force behind the publication of his *De revolutionibus*, was an astrologer (Kraai 2003)? That Tycho Brahe (1546–1601), Galileo Galilei (1564–1642), and Johannes Kepler (1571–1630) cast horoscopes, not wholly as a cynical wage supplement, but because at some level they

believed in the practice (Thoren 1990, 120–122, 213–219; Heilbron, 2010, 90–94; Caspar 1993, 181–185)? That the founder of the Cassini dynasty in France (G.B. Cassini 1625–1712) started out as a believer in astrology (Heilbron 1999, 83–84)? That Joseph-Nicolas Delisle (1688–1768), staunch Newtonian and teacher of Charles Messier, and the most important architect of the Enlightenment program to observe the transits of Venus after Edmund Halley, cast horoscopes for nobles in a radical Enlightenment context early in his career (Shank 2008, 131)? And, finally, that Charles Messier (1730–1817) himself was driven to publish an astrological cometary tract in an attempt to gain Napoleon's patronage during a lean period (Delambre 1827, 773–774)?

All this is part of the historical record, and one has no choice but to acknowledge it in order to avoid the ahistorical presentist error that the great Dutch astronomer Antonie Pannekoek (1873–1960) mentioned to the Victoria Centre of the RASC in September of 1929: "... modern writers are in the habit of speaking of...astrology as a regrettable aberration of the human mind, and of trying to wash the famous astronomers of history clean from the stain of having believed the superstition" (Pannekoek 1930, 169). Astrology is a regrettable habit of mind, but so too is the urge to whitewash great astronomers of a different time who did practice it. You can always tell the heroes in Whig histories; they are prefigurations of us on the road to progress. It's a barren road that leads to nowhere.

What can or should you do when faced by an astrologer with attitude, who knows all this, and is eager to win your audience from you?

You can start by not losing sight of the fact that you are right. Astrology is part of the history of astronomy, but it is not part of astronomy as a modern science. That is non-negotiable. By all means admit that astrology is a subject worth studying as a cultural phenomenon. The great historian of mathematical astronomy, Otto Neugebauer (1899–1990), said as much when, in 1951, he famously justified his decades-long study of astrology, the "wretched subject" (1983, 3).

The ground you are standing on, the ground on which your audience has come to hear you, and engage in experiencing the modern discipline of astronomy, is a ground where data is carefully and systematically collected, where it is analyzed by tough and well-characterized methods, where instrumental error is quantified, where theories are critically developed and evaluated in response to the changing store of evidence against earlier versions and competing theories, and where publication is full, transparent, and rigorous. It is a ground on which astrology has no standing because it is not evidence based, nor are its techniques, practices, or theories subject to rigorous controls. It doesn't deserve to have ground ceded to it. This was definitively proven by Shawn Carlson in a celebrated study published in *Nature* in 1985, and further analyzed in *Experimentia* in 1988. It was also definitively demonstrated by Nicole Oresme (1320–1382) in the second half of the 14th century,

as it was by Aurelius Augustinus (354–430) in the 5th century AD (Coopland 1952; Oresme 1971; Augustinus 1955, 5, 2; Augustine 2012, 7.6.8–10).

Secondly, know the history of your discipline, so that you are not taken unawares by its strange and surprising course. Don't go to carelessly written popular works; you'll learn nothing, and learn it badly. John North's superb *Cosmos* (2008) will tell you what you need to know about how astrology interacted with astronomy through time. Don't let ignorance of that history be used against you to embarrass the modern astronomical enterprise.

Thirdly, despite what anyone may have told you, demeanour and rhetoric *do* matter. Treat your astrological opponent with courtesy and respect, whether deserved or not. You will win no points by behaving worse than the person attacking your position or attacking you. If your opponent is arrogant, let him or her reap their just reward, which will be to lose the audience. A poor manner can alienate an audience just as surely as a poor grasp of content.

I close with a thought and several unsettling questions. Canada seems to harbour its fair share of popular irrationalities, as do many technologically advanced countries, and while our population may not share a common dislike of modern science, it does seem at times to be uncommonly unaware of it. How much are we to blame for this? How effective is our EPO at fighting beliefs such as astrology? How good is it at conveying something of the workings, challenges, and problems of contemporary science? Do we promote astronomy and allied sciences in ways that really matter to our fellow citizens? Where is the fundamental challenge in context-free glimpses of the ring system of Saturn, the dance of the Galilean moons, or the lunar terminator, and how do those views illuminate anything about how real science is actually done? To what extent are we to blame for the relative success of astrologers in the midst of our popular culture? ★

R.A. Rosenfeld is a Contributing Editor of the Journal.

Acknowledgements

A version of this paper was originally given at the 2012 RASC General Assembly at the University of Edmonton. I would like to thank Prof. Doug Hube and his Edmonton Centre colleagues for the opportunity to present the work there, and the audience for their response. This research has made use of NASA's Astrophysics Data System. Any errors remaining are the author's sole responsibility.

References

Manuscripts, Books, and Articles

- Augustine (2012). *Confessions*. O'Donnell J.J. (Ed.). Oxford: Oxford University Press.
- Augustinus Hipponensis (1955). *De civitate Dei*. CCSL 47. Dombart, B. & Kalb, A. (Ed.). Turnhout: Brepols.
- Aveni, A. (2009). *The End of Time: the Maya Mystery of 2012*. Boulder, CO: University of Colorado Press
- Campion, N. (2012). *Astrology and Cosmology in the Worlds Religions*. New York, NY: New York University Press
- Campion, N. (2000). *Zodiac: Enhance Your Life Through Astrology*. London: Quadrille
- Carlson, S. (1985). A Double-Blind Test of Astrology, *Nature* 318, 5, 419–425
- Carlson, S. (1988). Astrology, *Experientia* 44, 290–297
- Caspar, M. (1993). *Kepler*. Hellman, D. et al (Ed. & Tr). New York, NY: Dover Publications Inc.
- Coopland, G.W. (1952). *Nicole Oresme and the Astrologers: A Study of the Livre de divinations*. Liverpool: Liverpool University Press.
- Delambre, J.-B.J. (1827). *Histoire de l'astronomie au dix-huitième siècle*. Paris: Bachelier
- Galileo's Astrology* (2003), Campion, N. & Kollerstrom, N. (Ed.), (*Culture and Cosmos* 7, 1)
- Gelfer, J. et al. (2011). 2012: *Decoding the Countercultural Apocalypse*. Sheffield: Equinox.
- Heilbron, J.L. (1999). *The Sun in the Church: Cathedrals as Solar Observatories*. Cambridge, MA: Harvard University Press.
- Heilbron, J.L. (2010). *Galileo*. Oxford: Oxford University Press.
- Kepler's Astrology* (2010), Greenbaum, D.G. & Boockmann, F. (Ed.), 2 vols. (= *Culture and Cosmos* 12).
- Kollerstrom, N. (2000). *Newton's Forgotten Lunar Theory: His Contribution to the Quest for Longitude*. Santa Fe, NM: Green Lion Press.
- Kollerstrom, N. (2006). An Hiatus in History: the British Claim for Neptune's Co-Prediction, 1845–1846, *History of Science* 44, 1–28, 349–371.
- Kollerstrom, N. (2012). *Gardening and Planting by the Moon 2013: Higher Yields in Vegetables and Flowers*. Slough, Berks: W. Foulsham & Co.
- Kollerstrom, N. & O'Neill, M. (1996). *The Eureka Effect: The Celestial Pattern in Scientific Discovery*, 2nd ed. London: Urania Trust.
- Kraai, J. (2003). *Rheticus' Heliocentric Providence*. Ph.D. thesis Ruprecht-Karls-Universität Heidelberg.
- Krupp, E.C. (2009). The Great 2012 Scare, *Sky & Telescope* 118, 5, 22–26.
- Krupp, E.C. (2013). Griffith Observatory, Apocalypse Police, *Griffith Observer* 77, 8, 2–17
- Neugebauer, O. (1983). *Astronomy and History: Selected Essays*. New York—Berlin—Heidelberg—Tokyo: Springer.
- North, J. (2008). *Cosmos: an Illustrated History of Astronomy and Cosmology*, 2nd ed. Chicago: University of Chicago Press.
- Oresme, N. (1971). *Nicole Oresme and the Kinematics of Circular Motion: Tractatus de commensurabilitate vel incommensurabilitate motuum celi*. Grant, E. (Ed. & Tr.). Madison—London: University of Wisconsin Press.
- Pannekoek, A. (1930). Astrology and its Influence Upon the Development of Astronomy, *JRASC* 24, 4, 159–176.
- Ptolemaeus, C. (1998). *Opera quae exstant omnia, 1, Apotelesmatika*, Hübner, W. (Ed.), BsG&RT 1746. Stuttgart: Teubner.
- Shank, J.B. (2008). *The Newton Wars and the Beginning of the French Enlightenment*. Chicago & London: University of Chicago Press.
- Sūnzǐ (1910). *Sun Tzu on the Art of War: the Oldest Military Treatise in the World*, Giles, K. (Tr.). London: Luzac.
- Thoren, V.E. (1990). *The Lord of Uraniborg: A Biography of Tycho Brahe*. Cambridge: Cambridge University Press.
- van Stone, M.L. (2010). 2012—*Science and Prophecy of the Ancient Maya*. San Diego: Tlacaélel Press.
- Westman, R. (2011). *The Copernican Question: Prognostication, Skepticism, and Celestial Order*. Berkeley, Los Angeles, and London: University of California Press.

Web sites

Astrodienst, www.astro.com (accessed 2013 July 28)

Footnotes

- 1 Also see Gelfer *et al.* 2011.
- 2 The establishment of the Sophia Centre within an accredited degree-granting university attracted considerable controversy; it was at Bath Spa University 2002–2007, until that institution reconsidered *their* reputation, and the Centre shifted to its current home in a rather reduced condition. The establishment of the Sophia Centre was—and is—broadly seen outside the astrological community as an attempt to gain academic respectability for a cultural practice singularly devoid of rigour. And so it is—but it must be granted that some acceptable sociological and historical work on astrology in society has been produced under its auspices (*Galileo and Astrology*; *Kepler and Astrology*; Campion 2012). The aura of unfortunate associations remains, nonetheless (the current head of the program has produced works such as Campion 2000).
- 3 The publisher of the lunar gardening book is based in Slough, England, and the Herschels were based there from 1786–ca.1840; one could be forgiven for thinking the town's scientific capital has diminished in the intervening years.

Rendezvous with the Stars and the Universe, Too

by Maureen Arges Nadin, Thunder Bay Centre
(mnadin@shaw.ca)

“We’re all made of star stuff.” Carl Sagan, the late and great popular astronomer who brought science to the masses, immortalized those words when he first coined the phrase back in 1980 in the now legendary documentary *Cosmos*. Since then, I have heard it quoted many times, often by people who don’t know its origin. Some months ago, a distant cousin in Ireland, learning of my interest in space and astronomy, emailed me and said “I have heard that we are made of star stuff,” and then innocently asked “What does that mean?”

My cousin would have enjoyed attending the 2103 General Assembly of The Royal Astronomical Society of Canada (RASC) that was held in Thunder Bay, which I had the pleasure of attending as both a delegate and volunteer. He would have had his question answered, and perhaps even more; to the delight of like-minded folks who are curious and impassioned by the concept of discovery, he would have come away with even more questions to ponder.

The well-attended conference, which was hosted by the local Centre of the RASC and, in a classic example of the stars lining up (although technically it’s planets that align), it coincided with both the 25th anniversary of the Centre as well as the official opening of the David Thompson Observatory at Fort William Historical Park. In partnerships with both Fort William Historical Park and Lakehead University, the Centre was able to bring in three well-respected and provocative guest speakers, and in the tradition of Carl Sagan, who first engaged the imaginations of the non-scientific community, invited the public to attend. Although there was plenty to satisfy the more technically inclined, such as night-sky photo workshops with an expert, an opportunity to view the Martian landscape in the university’s 3-D lab, and a solid lineup of white papers in the latest research in astronomy, it was the theme of the public

presentations that particularly captured the interest of the more philosophically minded star gazers like me. The diversity of topics illustrates what I feel is one of the strengths of the RASC—its ability to reach out to amateur astronomers and backyard stargazers alike. I’m definitely in the latter category. Having always been somewhat technically challenged, I don’t own or use a telescope, preferring the relative ease of binoculars or the naked eye. The science helps me understand what I am looking at, but once I get there, it’s all about the wonder. And a little bit of existential soul-searching as I ponder what is out there and gasp—yes—what it all means.

California Astronomy lecturer and sky photographer Dennis Mammana, gave the first public presentation, “Our Cosmic Roots,” and his talk laid a good foundation for some of those more philosophical yearnings. He not only answered my cousin’s question (the planetary disks that formed the planets contain the remnants of massive star explosions called supernovae, and organic life as we know it evolved from there), but he challenged us to take that even further. He reminded us that not only is Carl Sagan’s famous statement literal as well as metaphorical, but he challenged us to consider what I think would be an obvious, albeit rhetorical, question for all of us by now:

“The chemical ingredients for life exist everywhere in the Universe. If it happened here, why would it not happen elsewhere?”

The next two presentations gave us an overview of the science and the technology that are going to help us discover the answer to that question. On Friday night, Sara Seager, well-known astrophysicist, planetary scientist, and MIT professor, gave us the latest on NASA’s *Kepler* mission, the space telescope that was searching the sky for extrasolar planets (planets that orbit other stars) and for which she is one of the leading researchers. Her youthful appearance caught some of the audience by surprise, given the depth of her knowledge and expertise. She deftly engaged the audience

Continues on page 207...

Pen & Pixel Extra!

Scenes from the General Assembly



Figure 1 — Brian McCullough receives a Service Award from President Glenn Hawley. Photos (all) David Clark (London).



Figure 2 — Three original members of Thunder Bay Centre, Ted Bronson, Beverly Bishop (widow of the late Bob Bishop), and Jim Zeleny cut the Anniversary Cake at the General Assembly dinner.

Delivering the Universe ... in very compact packages!

Observer's
Calendar
\$17.95*

Your guide
to daily
astronomical
events.



OBSERVER'S
HANDBOOK
2014

Observer's
Handbook
\$27.95*

The must-have
resource for
astronomers.

FREE PC
planetarium
software inside
every copy!



* Plus S&H and applicable taxes.
(May be available through your local Centre.)

MASA, ESA, and the Hubble SM4 ERO Team



The Royal Astronomical Society of Canada – 29 local Centres from coast to coast.

For more information and to learn about membership
call toll free 1-888-924-7272; email mempub@rasc.ca; or visit us online

rasc.ca

Pen & Pixel Extra!

Scenes from the General Assembly

Figure 3 — The Okanagan Centre's Alan Whitman receives the Simon Newcomb Award.



Figure 4 — Dr. Sara Seager and President Glenn Hawley.

Figure 5 — Robert Duff from the London Centre receives the Qilak Award for his outreach activities.



Pen & Pixel



Figure 1 — Randy Krall from the Nanaimo Astronomy Society captured this image of the Helix Nebula from a dark-sky site north on Vancouver Island. Exposure is 10×5 min in L, 6×5min in R and G, and 7×5 min in B. From his vantage point, the Helix rises only 20 degrees above the south horizon. Randy used an ATIK 314E camera on an 80-mm APO refractor with a 0.8× reducer.

Figure 2 — Joel Parkes caught this triple conjunction of Venus, Jupiter, and Mercury (in order, from bottom) in deep twilight last May. The scene was widely viewed across the RASC as the three planets changed positions over a period of several days during their orbital dance. Exposure was ½ second at f/5.6 and ISO 800, using an 80-mm lens.





Figure 3 — Summer is noctilucent cloud season for those of us who live above the 49th parallel, and Sheila Wiwchar of the Winnipeg Centre was ready and waiting on June 6 when the skies put on this show. The delicate tracery of pearl-coloured clouds is a hallmark of noctilucent clouds, which form high in the atmosphere where they are illuminated by a below-the-horizon Sun.

Figure 4 — It looks like a coloured tadpole swimming in an algae-laden pond, but this offering from Lynn Hilborn is actually a wide-field scene stretching from the Cocoon Nebula (IC 5146) to M39. The “trail” is the dark nebula complex B168. Lynn used a 200-mm f/2.8 Canon lens on an FLI ML8300 camera with an exposure of 12×5 min in RGB, 16×10 min in L, and 3×15 min in H α .



Continued from page 202...

by utilizing both compelling visual images and a lecture format to explain how *Kepler* found planets using the transit method, monitoring the “dip” in a star’s light as the planet crossed in front of it. The ultimate goal, Dr. Seager explained, is to answer some of those “big questions,” such as; Are there potentially habitable worlds out there? Dr. Seager also said that, because we we have water vapour in our atmosphere, “we are looking for water vapour in other worlds.”

In a white paper later presented to delegates, Dr. Seager told us how that search would become even more focused when *Transiting Exoplanet Survey Satellite (TESS)*, the 2nd-generation space telescope, launches in 2017. *TESS* will search closer to home and focus on stars that are nearby and bright, and it’s expected that *TESS* will discover 300 Earth-like planets.

And, while *Kepler* and *TESS* search from the sky, Earth-based telescopes such as the Thirty Meter Telescope will be adding considerable power to the search. Dr. Ray Carlberg, University of Toronto astronomy professor and the Canadian lead on the 30-metre project, told us during the final public presentation that the massive telescope, when completed later this decade, will search out the origins of the Universe, looking at how galaxies and planets evolved. He reminded us that just 15 years ago, the only Solar System that we knew of was ours, and now we have discovered thousands.

Things are moving quickly and science and technology are bringing us closer to potential discoveries and revelations that

will impact us in ways that go far beyond science. Although I’m sure that not everyone came away from the conference with the philosophical, and if I daresay spiritual, musing that I did, it would be difficult not to be inspired by the thoughtful questions that were raised. I hold firm in my belief that it is only a matter of time before we discover something other than ourselves “out there” in the vastness of the Universe, and when we do, we will be changed forever.

And in the ultimate irony of the week, the gal who doesn’t use a telescope won the door prize, which happened to be a Celestron telescope. Fortunately, I have two helpful sons-in-law who saved me from my technical ineptitude and assembled it in seemingly record time. Now I will be able to relate to the reflective words of Ted Bronson, Thunder Bay’s former *Chronicle-Journal* astronomy columnist and long time member of the local RASC executive, who spoke about his time in the Thunder Bay Centre as a founding member. People see and perceive creation in many different ways, and we may have to revisit those beliefs and concepts some day, but for Ted it is as clear as the glittering stars on a cold, dark night:

“I see creation every time I look through my telescope.” ★

A similar version of this column was originally published in the Thunder Bay’s Chronicle-Journal.

Maureen Arges Nadin is a freelance writer and space enthusiast. She writes the Cosmic Neighbourhood column in the Chronicle-Journal.

A Tribute to Jim Hesser

*by Prof. John R. Percy, RASC Honorary President
(john.percy@utoronto.ca)*

Dr. Jim Hesser, Director of the Dominion Astrophysical Observatory in Victoria, completed his four-year term as RASC Honorary President at the 2013 General Assembly in Thunder Bay. His service to the RASC has been long and exemplary. It was most intense, starting in 2005, when he chaired International Year of Astronomy (IYA) in Canada—a partnership between the RASC, the Fédération des astronomes amateurs du Québec (FAAQ), the Canadian Astronomical Society (CASCA), and many other parts of the Canadian astronomical community.

Jim’s achievements, in this role, were many and varied. As Chair and “single point of contact” (SPoC), he set up and maintained an effective three-way communication between the international organizers of IYA, the IYA Canada committee, and the 324 liaisons in Canadian clubs and institutions, and he

represented Canada effectively on the “world stage,” presenting numerous talks and posters on IYA Canada—all of them in close consultation with the RASC-FAAQ-CASCA partnership. He ensured that an evaluative survey of IYA Canada was conducted and acted upon, halfway through the year, and a final reflective report was prepared. It is summarized in JRASC 104, 51-56 (2010).

Jim provided encouragement, wise advice, and practical assistance with almost every major IYA project in Canada—the circulating stamps and commemorative coin, the popular free handouts and other resources developed by the RASC and FAAQ, the lecture series highlighting Canadian astronomy, the multi-site planetarium show, and the light-pollution initiatives. He personally gave enthusiastic lectures on IYA at RASC Centres and other venues across Canada. He contributed significantly (and obviously with great enjoyment) through his personal IYA projects, notably the astronomy-themed public and educational concerts developed and performed by the Victoria Symphony Orchestra under its Music Director Tania Miller.

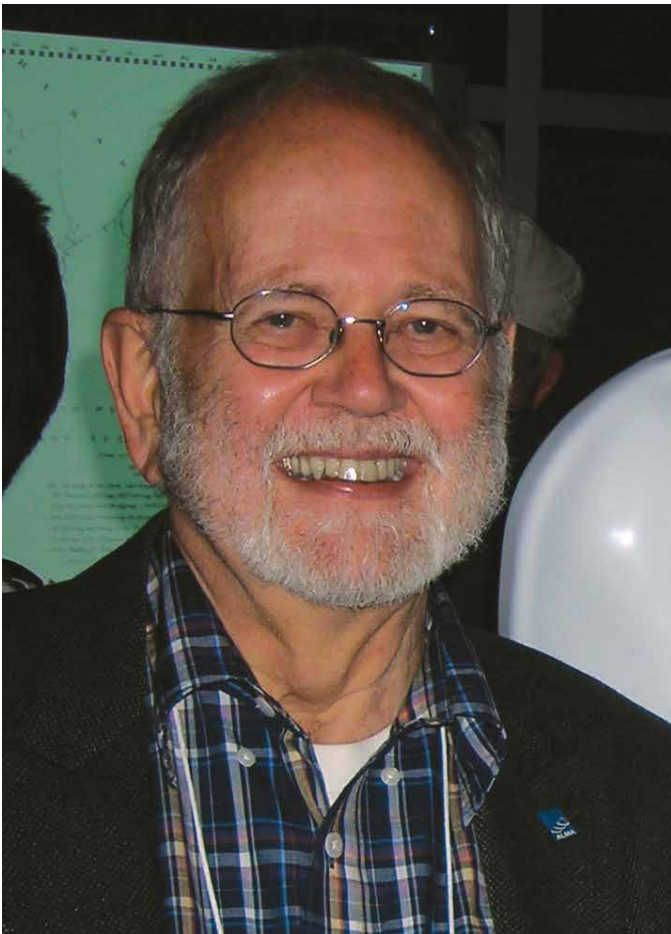

Jim Hesser. Photo credit: Chris Gainer.

Perhaps most importantly, Jim forged an effective partnership between RASC, FAAQ, and CASCA— organizations that had not previously interacted or worked closely together. These partnerships extended to organizations outside the astronomical community. Notably, with Cheryl Bartlett, Andy Woodsworth, and others, he worked diligently and effectively to establish respectful, inclusive partnerships with Canada's Aboriginal communities, to preserve and celebrate indigenous astronomical knowledge, to preserve dark skies for Aboriginal and non-Aboriginal Canadians, and to illustrate pathways by which Aboriginal youth can aspire to, and enter, careers in science and technology. This led to Jim's role in guiding *Beyond IYA*, a follow-up project to maintain the momentum of IYA, and especially to extend its benefits to groups that are not traditionally well-represented or served by science and technology.

Jim was probably the most active and engaged RASC Honorary President ever. His work in this role followed naturally from that, as chair of IYA Canada. He and the RASC already had a strong mutual understanding, respect, and admiration, both from his long-time support for the Victoria Centre and from his role in IYA Canada. From his day job, Jim brought experience and superb organizational and administra-

tive skills. These skills were much appreciated as the RASC modified its governance to conform to new federal requirements. He continues to serve on the Constitution Committee, providing sage advice, support, inspiration, and encouragement—a true cheerleader. He has and does provide similar support for the Society's education and outreach activities, which, like Jim, have been recognized by a Michael Smith Award. He also came to as many meetings as possible (despite his many other duties), and he and Betty attended each GA during his four-year tenure.

Outreach, of course, is only part of Jim's day job. He has enjoyed a productive research career, with over 180 publications—especially in the areas of atomic spectroscopy, variable stars, and globular star clusters. He was one of the pioneers of high-speed photometry of objects such as pulsating white dwarfs. Since 1986, he has been Director of the Dominion Astrophysical Observatory in Victoria. This has been a major challenge, especially in the last few years with budget cutbacks and the federal government's repurposing of the National Research Council as a purely applied-science organization. He eloquently championed the DAO's capabilities in very difficult times. He built up the DAO's outreach programs, including the Centre of the Universe visitor centre (now closed).

Jim's leadership extends to the professional as well as the amateur community. He served admirably as President of CASCA in 2004-2006, President of the Astronomical Society of the Pacific in 1987-1989, and as Vice-President of the American Astronomical Society in 1991-1994, as well as on dozens of committees and boards, both in Canada and beyond.

Jim has rightly been recognized by many awards and honours: The Queen's Golden Jubilee Medal and an asteroid *Jameshesser* in 2002; the CASCA Executive Award in 2010; and the CASCA Qilak Award in 2013 for outstanding contributions to astronomy outreach and communication in Canada. In 1997, he was one of the first to receive the prestigious Michael Smith Award—a national award for excellence in science outreach and communication. This was an indication that his contributions to astronomy education (both formal and informal), outreach, and communication in Victoria, in B.C., and across Canada have been significant and sustained throughout his career in Canada.

Most of all, Jim brings enthusiasm and positive energy to everything he does, especially his leadership of the astronomical community in its broadest sense. For me, he is both an inspiration, and a hard act to follow!

I thank James Edgar and Glenn Hawley for their input to this article. ★

John Percy is Professor Emeritus, Astronomy & Astrophysics, and Science Education, University of Toronto, and RASC Honorary President for 2013-2017.

Through My Eyepiece

The Big Picture



by Geoff Gaherty, Toronto Centre
(geoff@foxmead.ca)

For most of my “career” in amateur astronomy, I’ve mostly concentrated on small things, as measured in terms of angular diameter. Planets, the Sun and Moon, double stars, most deep-sky objects ... all are very small objects, ranging from point sources to, at most, objects half a degree in diameter.

Four years ago, I started writing a weekly article for the Web site Space.com (www.space.com). Its goal is to alert readers to upcoming celestial events, primarily observable by inexperienced observers with little or no access to optical equipment. Along the way, I was expected to demonstrate the graphical capabilities of *Starry Night* software.

This has proved to be an enjoyable and sometimes challenging project: enjoyable because it has forced me to look at the bigger picture of constellations and the interactions between the Sun, Moon, planets, stars, and deep-sky objects; challenging because it can be difficult to come up with a new and different event 52 weeks of the year.

When I write my weekly column, my starting point is the “Bible” of astronomical activity, our beloved *Observer’s Handbook*. Each month, I mine “The Sky Month by Month” for upcoming events. I first use this to compile the monthly SkyCal feature of *Starry Night*. This is a file of sky events and links to *Starry Night* depictions of them, which is automatically downloaded by the program, along with files of current asteroids, comets, and satellites. I then use this material to write a monthly article for Space.com on these events, concentrating on the ones visible from North America where most of our readers are located.

The next thing I do is scan the month’s upcoming events and then break them up week by week. This is where the challenges begin to appear. Some months have more events than I can cover; others have fewer.

I also need to take into consideration that I have a colleague at Space.com, Joe Rao, who writes a similar series of columns. We share our proposals every month to avoid treading on each other’s toes, though some events are interesting enough that it doesn’t hurt to have two different approaches to them.

What to do if I have a week without an interesting event? I will instead write about some remarkable lunar topography that is well placed (if the Moon is in the sky) or objects of interest in a particular constellation (if it’s a dark-sky week). I

also try to draw readers’ attentions to the large-scale changes in the night sky over the year—what I have come to think of as the big picture.

I often take cues for topics from the questions I’m reading, as mentioned in my last column. There are many things about the night sky that puzzle the average person. To people who rarely look at the sky, the normal clockwork motions of Earth, the Sun, Moon, planets, and stars may seem random, haphazard, and downright weird. In fact, you’d be surprised how often that last adjective is applied to perfectly normal sky events.

As always, I find that my attempt to educate people ends up with me teaching myself. One of the first things I learned was how rapidly the Moon’s motion carries it across the sky and brings it into proximity with bright stars and planets. Such conjunctions are extremely common—far more common than I had ever noticed when I was concentrating on single objects.

Another discovery I made was how much the Moon’s appearance can change depending on the current angle of the ecliptic to the horizon, combined with the Moon’s position in its orbit. The many angles the Moon’s terminator can assume is the cause of much puzzlement to casual observers of the sky, who assume that the Moon’s terminator is always more or less vertical, as shown in textbooks. There is a whole collection of videos on YouTube about how the Moon has “come off its axis!”

Most of all, I have become aware of how the various aspects of the sky change over the course of a year. Not just the progress of the seasons and constellations, but the paths, rising points, and setting points, not just of the Sun, but also of the Moon and planets. In decades of observing the Moon in detail, I had never noticed how far north it could rise and set, depending on the time of night and time of year.

There are always new surprises and new things to learn, which continues to hold my interest in astronomy. ★

Geoff Gaherty received the Toronto Centre’s Ostrander–Ramsay Award for excellence in writing, specifically for his JRASC column, Through My Eyepiece. Despite cold in the winter and mosquitoes in the summer, he still manages to pursue a variety of observations. He recently co-authored with Pedro Braganca his first iBook: 2012 Venus Transit.

RASC members receiving this *Journal*
in electronic format are hereby granted
permission to make a single paper
copy for their personal use

Cosmic Contemplations

An Ultraportable Open, Folded, 8.5-inch $f/12.5$ Refractor



by Jim Chung, Toronto Centre
(jim_chung@sunshine.net)

I think that there is no better optical instrument for astronomical imaging than a refractor. Refractors can be permanently collimated, can be quickly cooled, are immune to tube currents, and produce the highest-contrast images since there is no energy-robbing central obstruction. Often a small refractor will seemingly outperform a much larger aperture Schmidt-Cassegrain or reflector, because larger scopes tend to be more sensitive to the seeing conditions, and the high-contrast views of refractors make them appear to out-resolve their theoretical limits.

However, well-colour-corrected or chromatic-aberration-free refractors using extra-dispersion (ED) glass become prohibitively expensive as apertures increase above four inches in diameter (interestingly this high expense is because of economies of scale, as there is no demand by consumer camera companies for ED glass larger than 4" for the manufacture of camera lenses). The current obsession with *airline compact* refractors is another example of the consumer gadget frenzy, dictating scopes that are thinner, lighter, and smaller. In the 1960s, amateurs enjoyed chromatic-aberration-free reasonably priced refractors (using normal glass) such as the classic *Unitron* long-tube, high-focal-length scopes. A simple rule (devised by Sidgwick) states that chromatic aberration (CA) becomes negligible when the focal ratio (f) divided by the diameter in inches is greater than 3; that generally speaking, higher focal ratio decreases chromatic aberration. Today, companies like *D&G Optical* specialize in making large aperture, high- f -value achromatic doublet refractors, but these are monstrous optical tube assemblies (OTAs) greater than 10 feet in length requiring equally monstrous mounts to support them.

The execution of a folded-refractor design to address unwieldy OTA lengths had never really seized the minds of amateur telescope makers, until the late Ernie Pfannenschmidt (Victoria RASC) reintroduced the concept in the March 2001 issue of *Sky & Telescope* magazine. This apparent lack of interest was surprising, as folded refractors were available from both *RE Brandt* and *Unitron* until the end of the 1980s. A folded refractor uses one or more optically flat mirrors to redirect the light path back onto itself, thereby reducing the apparent OTA length. The redirections can be outside the plane of the main

light path, allowing the eyepiece to be uniquely placed along the RA axis. This placement allows the visual observer to stay in position the whole night long, even while the scope and mount are tracking an object across the sky.

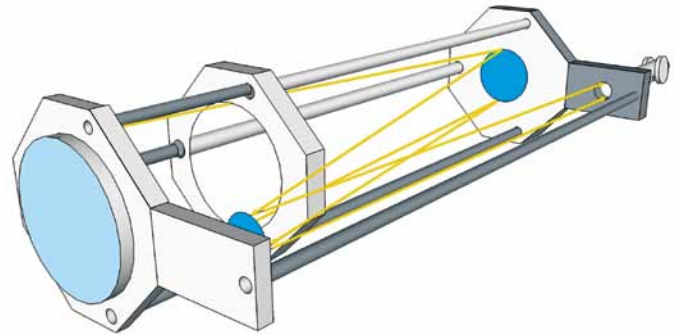

Figure 1 — Jim's 8.5" achromatic $f/12.5$ folded open refractor.

I was fortunate to recently acquire a used 8.5" $f/12.5$ *D&G* lens and cell and decided to build a refractor that was small enough to transport in a normal car and light enough to be mounted on an affordable German equatorial mount (GEM). Although I typically use my 12" $f/5$ Newtonian to image planets, it is very difficult to transport to star parties, and one needs aperture to show planets at their very best. The Newtonian's secondary mirror has a central obstruction of about 3", which in practice means it delivers contrast similar to a 9" aperture refractor. Although the Sidgwick ratio of the lens is only 1.5, stopping down the lens to 6" will produce a ratio of 3 if the chromatic aberration (CA) proves too intrusive. By folding the light path twice, I can reduce the original 9-foot OTA to less than 3 feet; by using a pole frame, the open telescope can be both lighter in weight and quicker to cool down; by making the poles retractable, the OTA length can be reduced to only 2 feet for storage and transport!

The focal length of the *D&G* lens was confirmed to be 106 inches by focusing the image of the Sun onto a piece of plywood and measuring the distance between the two. Four bulkheads are made from high-quality $\frac{3}{4}$ " Baltic Birch plywood. The aluminum tubing was sourced from nearby *Maple Leaf Communications*, which markets it for building shortwave radio antennae, and the self-locking, telescoping tube buttons came from *McMaster Carr*. Optical flats were bought from eBay and mirror coated by Normand Fullum (Quebec).

The flat sizes (a 6" and a 3", both rated at $1/10$ th wave surface accuracy) and the baffle opening sizes were calculated by considering the light cone as an isosceles triangle and the bulkheads the bases of a series of similar triangles. A scale-rendered drawing greatly helps to determine the size and position of the secondary and tertiary baffle openings.

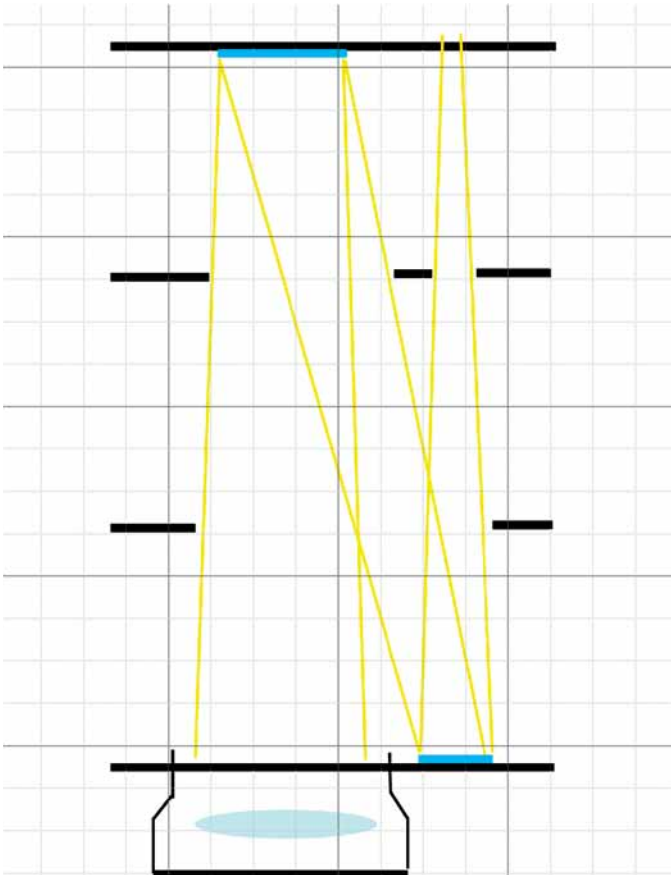

Figure 2

At this point I would like to dispel the notion that complex ATM can be performed only by skilled tradesmen within well-equipped workshops. My workshop is my driveway, and I work with rudimentary portable tools and the knowledge gleaned from watching too many home-improvement TV shows. The more projects that one undertakes, the more comprehensive the set of tools one will naturally acquire for seemingly little financial outlay. The devout ATMer can be found prowling the aisles of Canadian Tire and Princess Auto for their weekly bargains. This project took one week to complete, working a few hours each day. However, planning and acquiring parts took about four months (which also includes time waiting for spring to arrive).

To mount the scope, I recycled the 3-foot-long Losmandy-style dovetail plate that I made for the EMCCD project and attached it to a solid-oak base straddling the aluminum tubing

between the two central bulkheads. This structure was further reinforced with a pair of $\frac{1}{4}$ " 90° angle aluminum tubes. The aluminum tubes were connected to the bulkheads with the use of 1" and $\frac{7}{8}$ " internal diameter shaft couplers (*Fastenal*). The optical-flat cells were made from PVC drain-pipe caps with reduced thickness and mounted on three equidistantly spaced spring-loaded screws. The length of these screws can be altered with attached wingnuts, allowing three-dimensional positioning of the cell. The optical flats were passively glued to the cells with a judicious application of silicone sealant.

Collimation of all these optical elements can appear to be complex but is quite simple with the use of a laser collimator of the type used with Newtonian reflectors. I used the 2" *Hotech* laser collimator with the self-centring adapter. I cut paper circles with marked centres to attach on all three optical surfaces and centred the focuser to the 3" optical flat. I used a *JMI EV-2nM* motorized Crayford focuser, which has built in orthogonal adjustment on the mounting plate; alternately, one can adjust any focuser with custom shims. I then adjusted the 3" flat until it was centred on the 6" flat, and then the 6" flat until it was centred on the lens objective. The lens cell has push/pull adjustment and was collimated when the return beam reflecting off the back of the posterior lens element was centred on the *Hotech's* targeting faceplate. The lens itself had been recently returned from *D&G Optical* with its elements cleaned and with the correct air-gap spacing.

While not the featherweight I envisioned, the completed scope weighs in at 50 pounds, which is significant savings over the original 9-foot-long, 85 pound conventional refractor.

At 100× visual magnification, one can easily observe significant CA around Vega, but initial experiments with an Aries Chromacor were very promising, since they reduced the violet haze to levels nearly undetectable. The Moon surprisingly showed no visual CA and also none when imaged with a DSLR camera. Saturn was also similarly imaged. I even managed some narrowband deep-sky-object imaging with 10-minute guided subexposures of M57. Perhaps the best test of optical performance came during the Toronto Centre's July city-observing session. Despite the low sky position of Saturn, the seeing was near excellent that hot and humid night and we were able to observe a stable image of Saturn at 600× magnification, well beyond the theoretical limits of an 8.5" scope.

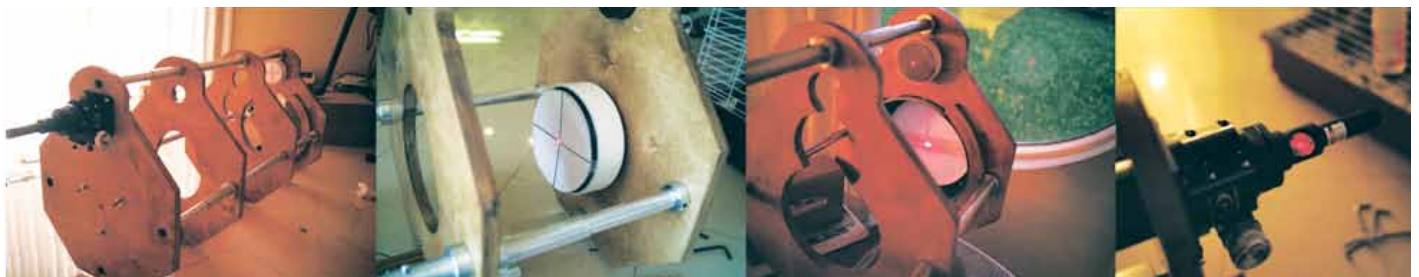

Figure 3



Figure 4

It was truly my best visual experience of Saturn: crisp with horizontal disc bandings just perceptible and a Cassini division big enough to fall through! ★



Figure 5

Jim Chung has degrees in biochemistry and dentistry and has developed a particular interest for astrophotography over the past four years. He is also an avid rider and restorer of vintage motorcycles, which conveniently parlayed into ATM (amateur telescope maker) projects. His dream is to spend a month imaging in New Mexico away from the demands of work and family.

Imager's Corner

Restoring Star Colours



by Blair MacDonald, Halifax Centre
(b.macdonald@ns.sympatico.ca)

This edition continues a group of Imager's Corner articles that will focus on a few techniques that are useful in processing astrophotos. Over the next several editions of the *Journal*, I'll continue with a guide to several techniques that I find most useful. All the techniques discussed will be useable with nothing more than a standard image processor that supports layers and masks. No special astro-image processor is required.

This edition will deal with recovering colour in images that have been stretched to the point where the star colour has been bleached close to white. The technique works because the stellar image usually has a Gaussian profile (Figure 1), where only the central area has had the value of the colour channels stretched to 255. When each colour channel approaches the maximum value, much of the star colour gets lost and the image loses some punch (Figure 1). The trick is to smear the

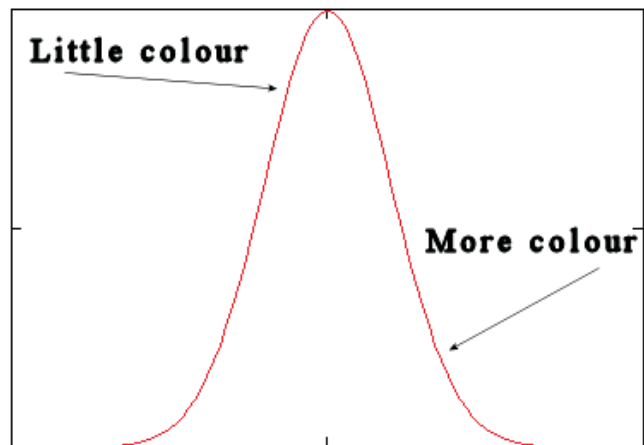

Figure 1 — Stellar Gaussian profile.

colour from the tails of the Gaussian so it covers the entire star, and then greatly boost the saturation. This sounds reasonable, but the effect on the rest of the image is intolerable. Like a lot of astro-processing, it is a case of layers and masks to the rescue. Start by duplicating the image on another layer. Now blur this layer with a Gaussian filter having a width of three or more. Blur the image enough to spread the colour from the tails of the stellar image throughout the whole star. Next turn up the saturation rather drastically on this layer, and set



Figure 2 – The original low-colour image

its combine mode to colour. Now there should be lots of star colour, but the rest of the image will look like crap, so a star mask made from the original image is used to combine the two layers and limit the colour boost to the stars.

Let's take a look at an image of a star field near the Iris Nebula in Figure 2. As you can see from the image, there is very little star colour due to the stretch applied to make the nebula

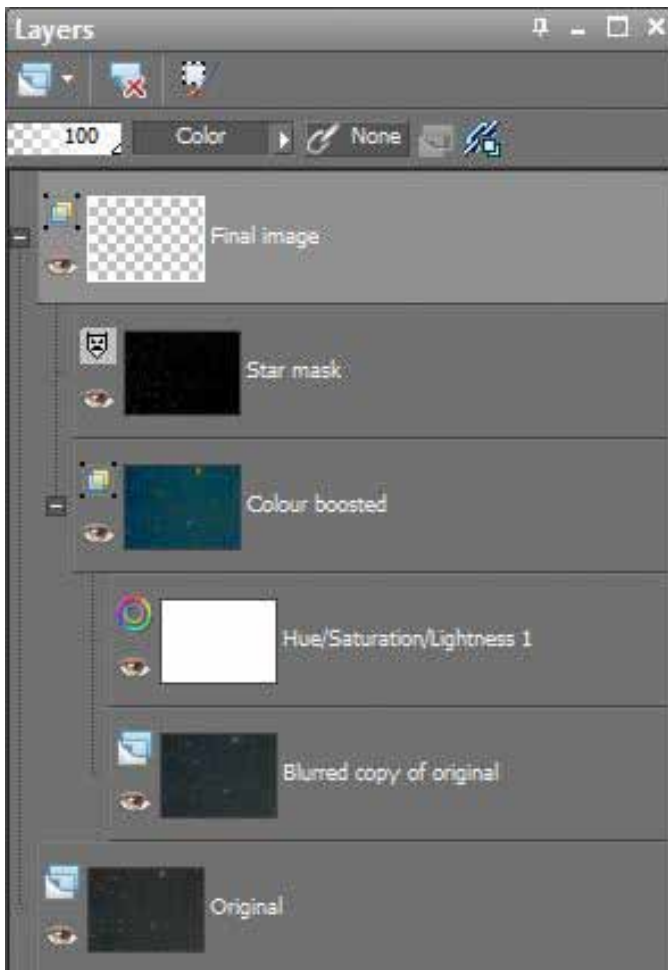

Figure 3 – A screen shot of the layer stack



Figure 4 – The final image with enhanced star colours

visible (it's out of the frame in the lower right). Now we apply the layer stack used to boost the star colour as shown in Figure 2.

This produces an image with much more star colour, but no artifacts in the sky background or the deep-sky object (Figure 4).

It is important to make the star mask from the original image so that the effect will be limited to the cores of the stars and, with a little blurring, will help to blend the effect into the background.

The same technique with a different mask and no saturation boost can be used to remove much of the colour noise from an image, but that is another column.

Remember, this column will be based on your questions so keep them coming. You can send them to the list at hfxrasc@lists.rasc.ca or you can send them directly to me at b.macdonald@ns.sympatico.ca. Please put "IC" as the first two letters in the topic so my email filters will sort the questions. ★

Blair MacDonald is an electrical technologist running a research group at an Atlantic Canadian company specializing in digital signal processing and electrical design. He's been an RASC member for 20 years, and has been interested in astrophotography and image processing for about 15 years.

The Royal Astronomical Society of Canada is dedicated to the advancement of astronomy and its related sciences; the Journal espouses the scientific method, and supports dissemination of information, discoveries, and theories based on that well-tested method.

Rising Stars: Peter McMahon—From *Star Wars* to *SkyNews* and Beyond



by John Crossen
(johnstargazer@xplornet.com.)

“*Star Trek* was like a class trip into the future” – Peter McMahon

Peter McMahon is known to many as the Wilderness Astronomer for *SkyNews* magazine. His role as Contributing Editor is just one of many positions he has worked at over the years. But there’s more to Peter’s world of astronomy than journalism, so let’s go back to the launch pad where it all started.



Figure 1 — Stargazing by the shores of our cosmic ocean, at the world’s lowest tide near the Bay of Fundy’s Hopewell Rocks. Photo: Kevin Snair/creativeimagery.ca.

Peter’s interest in astronomy was ignited by a blast from a laser gun. Luke Skywalker was the culprit and *Return of the Jedi* was the film. According to Peter, as soon as the film was over he “ran out and gobbled up” the two other *Star Wars* “Video Kay-Settes” as his father used to call them.

Suddenly, exploding planets, weird stars, and space travel were major players in the theatre of his six-year-old imagination. Aided and abetted by the movie *Star Trek IV* plus numerous *Trek* TV reruns, books, and spaceship models, Peter grew up in a breathtaking world where he could “rocket around between stars and their planets like a weekend excursion.” It wasn’t long before fantasy slowly began to turn into reality. The first step was the well-intentioned gift of a wobbly legged telescope. Barely usable by any standards, Peter’s patience prevailed and on the first night, the scope showed him the craters on the Moon. That same night he saw a bright star that he thought

might be a planet. He gingerly inched the wobble-scope over to view it. Shazaam! It was Saturn and like a trout snapping up a lure, he was hooked.

Years later, Peter was still as enthusiastic about astronomy as he had been during the *Star Wars* era, albeit a lot more entrenched in scientific reality.

By Grade 10, Peter had acquired a serious 5-inch Newtonian telescope. With it, he witnessed one of the Solar System’s most amazing events—Comet Shoemaker-Levy’s segments bombarding Jupiter. For Peter, the event was a milestone and started him planning a career as a science journalist.

After five years of university-level journalism, almost a decade of science writing with Discovery Channel and CTV, and, later, as a freelancer for various other outlets, Peter’s dream of being a full-time space writer has finally come true. Science journalism was earning enough to be the only job he needed. Life is good!

Today Peter has expanded his audience to include *Canadian Geographic*, and *enRoute* (Air Canada’s in-flight magazine), and he has authored more than a dozen “Wilderness Astronomer” columns for *SkyNews*. Each of his wilderness articles singles out a different dark-sky location in Canada, so that readers can discover and learn about a different dark-sky experience with each article.

Says Peter; “I knew I could call myself a ‘space writer’ after my latest work with the Canadian Space Agency, essentially serving as Chris Hadfield’s science experiment biographer.”

During that time, Peter wrote Web-site text and YouTube scripts relating to Canadian research projects and elements of daily life that Chris experienced while serving as a crew member and commander of the *International Space Station*. Videos that Peter produced served as guideline scripts for Commander Hadfield that, to date, have garnered millions of on-line views. It has been a long, often times bumpy journey from Jedi Warriors to a successful career as a space writer, but that’s just the first stage of the rocket named Peter. He is also a very enthusiastic astronomy outreach person.

Ask Peter what got him into astronomy outreach and he’ll tell you in no uncertain words:

“I may not get too popular for saying this, but much of the astronomy outreach I’ve seen at every level has been downright awful. Too many healthy, vibrant, dynamic people have had to yawn through astronomy presentations. Small wonder they never revisited the hobby. Not only is some astronomy outreach failing to capture the awesome, magical, butt-kicking thunder that is space exploration, but some of that outreach has actually gone as far as to push the general public away from the night sky.”



Figure 2 — Peter McMahon (right) and photographer Yuichi Takasaka (left) at the Columbia Icefield's Athabasca Glacier in Jasper National Park and Dark-Sky Preserve. Photo: Yuichi Takasaka/blue-moon.ca.

Those aren't empty words. I have seen Peter in action at Astronomy Day events and the show is anything but boring. For instance, using leaf blowers fitted to wooden discs, Peter constructed a miniature hovercraft. When the power was turned on, the discs would float, allowing their school-age passengers to zoom across a flat cement surface. Peter also put on a rocket show for the kids. This turns the lesson about propulsion into an exciting contest to see whose rocket goes the highest. Suddenly science is cool, fun, thrilling—like it really is.

During a talk to the Peterborough Astronomical Association, Peter brought along an arsenal of astro-gadgets that today's kids—and us old geezers—can use to make stargazing easier and more fun. From simple point-and-peek hand-held planetaria to tablets that show you the whole night sky, there are plenty of apps and gadgets out there to perk up a stargazing session—and they make it a lot more enticing to newcomers than dull star charts and floppy planispheres.

Peter's push to put the excitement back into science has led him to form a company with astro-imager Rick Stankiewicz. Called The Peterborough Planetarium, it is a mobile, inflatable dome. What happens inside is what makes it special.

“Over the last year, we've been able to capture the audience more with a tarp, some shelves from Wal-Mart, a showroom-

model LCD projector, and a laptop than I've been able to do with almost any other writing, experimenting, or public-speaking projects.”

For starters, Peter and Rick have created custom horizons for each of the regions in the counties they will visit. Peterborough has the Peterborough lift locks, and Cobourg has its Victoria Beach. And, because different groups have varying attention spans and knowledge levels, they custom-code the shows to proceed at a pace and tone that is in line with the realities of their audiences. Says Peter, “We found ways to make the show we wanted— even when no single software would let us—by contriving Disney-theme park-like transitions. We even have ‘coming attractions’ that float by in the daytime sky as our shows begin.”

Imagination, excitement, and enthusiasm, are words that not only describe Peter McMahon, but also the elements he is restoring to science—especially astronomy.

Where is he off to next? What's out there? ★

John Crossen has been interested in astronomy since growing up with a telescope in a small town. He owns www.buckhornobservatory.com, a public outreach facility just north of Buckhorn, Ontario.

Cheap Stuff From China

Doing Astro-stuff with a Raspberry Pi



by Rick Saunders, London Centre
(ozzy@bell.net)

In my last article, I discussed using the credit-card sized Raspberry Pi (Pi) computer as a wireless serial and USB link. This project shows how to use one of these great little machines to automate exposures in time-lapse or long-exposure photography, to control a DC motor on a focuser or time-lapse rail, and to interface with a simple anti-dew heat circuit or fan. To this end, I have written a set of BASH (Bourne-again shell) scripts and designed a small circuit board.

Preparing a Pi for this project requires that two software packages be installed. The first is called *WiringPi* and the second is *gPhoto2*. *WiringPi* is a programming library and set of command-line utilities that, among other things, allows control of the Pi's general-purpose input/output (GPIO) pins. It is available at no cost on the Internet. *gPhoto2* allows control of a digital camera over USB and is in the repositories for your Pi's package manager. Once these are installed, you will need to download my package (see "Resources" at the end of this article for URLs and instructions for installing all software). This article is split into two major segments—software and hardware—with each having an explanation of the three functions stated above.

My Software

The package I have put together is comprised of the following scripts and programs:

- rpi-iv** C program that handles the scheduled opening and closing of the shutter
- dtethered.sh** Starts *gPhoto2* running in the background to automatically download images
- dfocus.sh X** Sets the camera's "half-press" mode for X seconds (or 2 seconds if not specified)
- shutter.sh X** Used to take an *ad-hoc* framing/focusing shot of X seconds
- dlpics.sh** Uses *gPhoto2* to download all of the images from the camera
- focus.sh** Controls a DC motor to turn a powered focuser in and out

There are other scripts and programs in the package, but they will be the subject of a future article.

Controlling a DSLR Shutter

The program *rpi-iv* opens and closes a DSLR shutter according to the command-line arguments that are passed to it. It can take up to five scheduling arguments and one "restart" argument. The scheduling arguments are all of the format *xxxx* where *xxx* can be any integer and *a* is one of the following letters:

- e** exposure length
- d** delay between exposures
- n** number of exposures
- p** pre-focus time
- m** mirror lockup time

A typical example would be `sudo ./rpi-iv 300e 15d 10n 5p 3m` which starts a sequence of 10 300-second exposures spaced by 15 seconds with 5 seconds of pre-focus and 3 seconds of mirror lock-up settle. The "sudo" is needed as *WiringPi* needs root access to initialize the system. The order that the arguments are passed is not important and none is absolutely needed. If no arguments are passed then the values used are three 1-minute exposures, 5 seconds apart.

The program writes two files that are used to restart an interrupted sequence where it left off:

- dparams** This file holds the sequence parameters.
- curexp** This file holds the number of the current exposure.

If you stop a sequence, that sequence can be restarted by issuing a single **r** argument (`sudo ./rpi-iv r`). Further, after entering the values in interactive mode, the program will ask if you wish to store the values. Typing "yes" will cause the program to prompt you for a filename. Once stored, you can reload the stored values by starting the program thusly: `sudo ./rpi-iv <filename>`

If you wish to have each image downloaded as it is completed, then run the script *dtethered.sh* before starting the imaging sequence. This will start the program *gPhoto2* in the background, which will transfer the images when the shutter closes. The script prompts you for a base filename (m27-apr-15 or something) and will then number the exposures with the suffixes "-001," "-002" etc.

One last thing; the program needs to know whether to use the colour interface, the kind of DSLR that is being used, and what pins to use. These values are stored in a file called "rpi-iv.conf." The file reflects the defaults used if the file does not exist in the directory in which the software lives.

Controlling a Powered Focuser

My package contains a BASH script called *focus.sh* that uses the Pi's functions to turn on and off a DC motor, time-lapse

rail, or any other thing that might need bi-directional control. The pins used are set in the script and it is invoked as follows:

The command “focus in|out -p [pulse length in ms] -s [speed]” is used to pulse the motor and the command “focus in|out -c -s [speed]” is used to run the motor until a key is pressed. For a full listing of command options, type “focus -h.”

Controlling an Anti-dew Heater

The package also contains a program called *antidew*. This allows you to use a pulse-width modulation (PWM) signal from the Pi to activate a suitable anti-dew heat strip controller. It is called as “antidew [percent].” Using 50 as percent will set the PWM duty-cycle to 50%.

The Hardware

Before the Pi can be used for this project, a small circuit board needs to be built in order to connect the various bits and pieces to the Pi. The schematic is shown in Figure 1 and reflects the default pin numbers used by the software. Of course, the scripts can be changed to reflect any changes made while making a circuit board. The compiled software needs to be reconfigured to change pin values. The schematic and a board layout in Eagle format can be found in the software package.

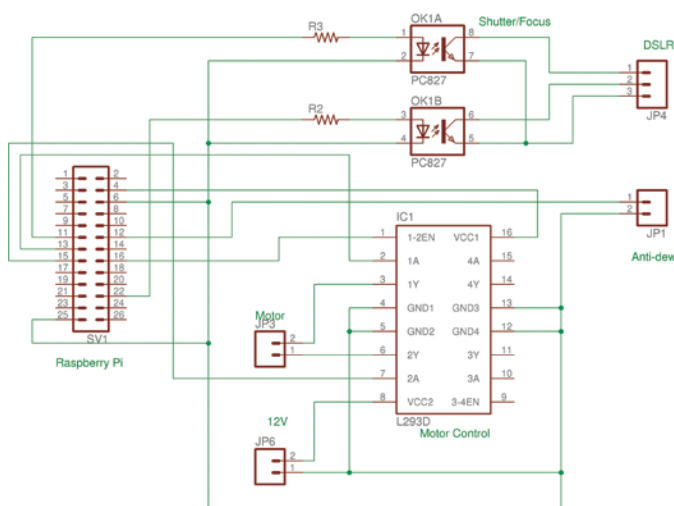

Figure 1

Shutter Control

DSLRs with wired remotes function by shorting one pin to the camera ground for focusing and another to trip the shutter. That is what the opto-coupler does when the chosen GPIO pin goes high. Shutter control uses three of the Pi’s GPIO pins, one for the shutter, one for the auto-focus/exposure functions, and one for a ground. Three matching leads run from the project circuit to the camera. The camera is electrically isolated from the Pi, so that one cannot damage the other.

This circuit is very simple. An opto-coupler is just an LED/photo-transistor pair, and when the LED lights up, the transistor passes current. So, what we are doing is using the Pi’s GPIO pins to turn on the internal LEDs. I use a PC827, which has two separate optos in one package, but if all you have around is a couple of single-channel parts, just use two of them.

I use a 3.5-mm stereo phone plug to interface to my DSLR shutter, but any three-contact plug will work as long as the correct connector for the camera is on the other end of the cable. Each camera brand uses a different scheme and Nikon, being Nikon, uses several different types with each one being a proprietary plug. Canon uses two types, but most of their DSLR cameras use a non-proprietary 2.5-mm stereo plug. Check your camera’s wired remote to see what kind of cable you will need to build. Cameras without a wired remote will not work with this project.

Focus-Motor Control

This circuit contains an L293D chip, which has the daunting name of “dual quad h-bridge with diodes.” This means there are transistors inside that are connected so that the chip can make a motor turn in either direction (two motors actually, hence “dual,” but we are only using one). The three pins that are used are an enable line, which we will turn on and off using PWM, and two inputs that will tell the chip the direction to turn the motor. 12V comes from an external battery to power the motor, as the Pi cannot deliver enough voltage or current to do the job on its own.

Controlling an Anti-dew Heat Strip

The circuitry needed is not on the main schematic as I have only broken out the hardware PWM pin on the Pi for use in whatever project might need it. I call it anti-dew as that is the most useful task for the signal in astronomy, but some external circuitry is required. This consists of another opto-coupler and its resistor, and a field-effect transistor (FET). The Pi turns the opto-coupler on and off rapidly, which, in turn, turns the transistor on and off. When connected to a heat strip, this provides the necessary energy to fight dew. The circuit (Figure 2) can be added to any board being built in order to keep things simple, or it can be constructed as an external add-on.

Putting it All Together

I created a circuit board with all of the functionality of this project using a good quality, through-hole plated prototype board (perf-board) from the schematic in Figure 1. I have found that the cheap boards are really no good for my style of work, as I tend to solder/unsolder/move leads several times. The normal single-side prototype boards tend to lose their solder pads doing that. The through-plated boards are much

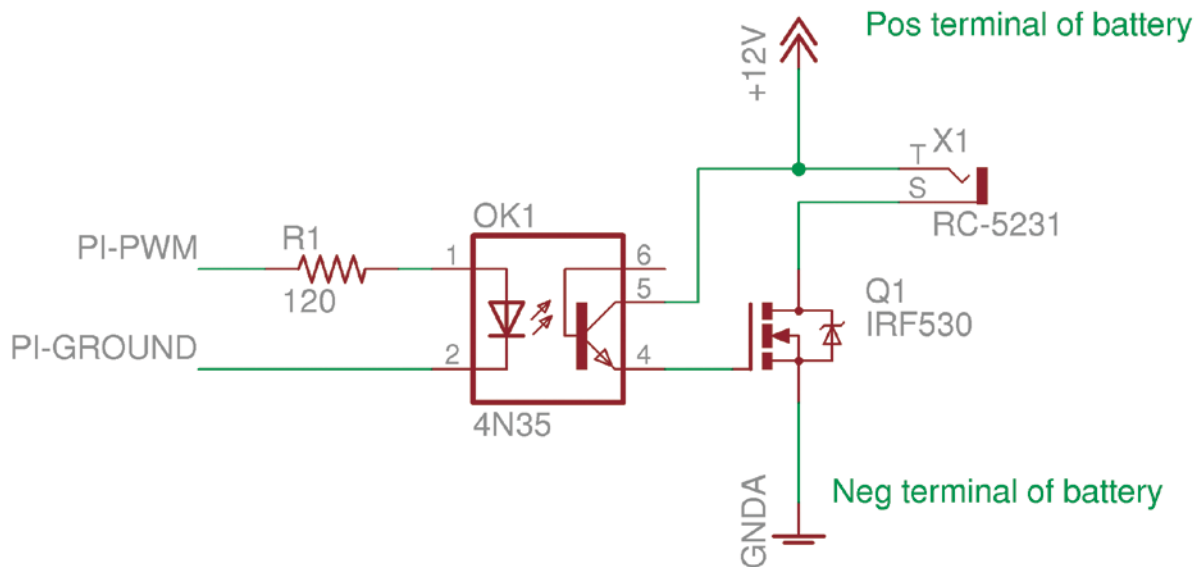

Figure 2

better. They are available on eBay for a few dollars each or at any good electronic supply outlet. A better solution would be to etch a circuit board, a task easily done in the basement but something that is outside the scope of this article.

Thus ends my first large astronomy project with the Raspberry Pi. I realize that it is nothing fancy, but then everyone should be able to work with a command-prompt. I hope it has been simple enough to follow. *

Resources

DSLR scripts

```
Install the zip package with: sudo apt-get install zip
Change to home directory: cd ~
Get the scripts with:
    wget
    (www.togastro.com/ozzzy/dslr.zip)
Create a directory: mkdir -p ~/dslr
Unzip the scripts: cd ~/dslr; unzip ../dslr.zip
```

WiringPi

(instructions at <https://projects.drogon.net/raspberry-pi/wiringpi/download-and-install/>)

```
Install git: sudo apt-get install git-core
Make sure your Pi is current: sudo apt-get update ; sudo apt-get
upgrade
Obtain WiringPi: git clone git://git.drogon.net/wiringPi
Install WiringPi: cd wiringPi ; sudo ./build
```

Gphoto2

```
Install: sudo apt-get install gphoto2
```

Rick Saunders became interested in astronomy after his father brought home a 50-mm refractor and showed him Saturn's rings. Previously a member of both Toronto and Edmonton Centres, he now belongs to the London Centre, and is mostly interested in DSLR astrophotography

WWW

RASC Internet Resources

Like us on facebook

Follow us on Twitter @rasc

www.rasc.ca
Visit the RASC Web site

www.rasc.ca/discussion
Email Discussion Groups

www.rasc.ca/contact
Contact the National Office

www.rasc.ca/rascnews
RASCeNews

On Another Wavelength

The Lunar Atmosphere and Dust Environment Explorer



by David Garner, Kitchener-Waterloo Centre
(jusloe1@wightman.ca)

There certainly appears to be a resurgence of interest in the Moon these last few years.

In 2009, NASA launched the *Lunar Reconnaissance Orbiter (LRO)*. The *LRO* was able to provide evidence of current geologic activity (small valleys in some parts of the Moon are slowly forming) as well as possible frozen water.

However, one very interesting discovery was made by the *Lunar CRater Observation and Sensing Satellite (LCROSS)*, which was launched with *LRO*. The *LCROSS* mission was to search for water ice in a permanently shadowed crater near the Moon's South Pole—and it found it in Cabeus crater. The discovery was the coldest measured temperatures in the Solar System.

In 2011, the *Gravity Recovery And Interior Laboratory (GRAIL)* mission sent dual spacecraft (called *Ebb* and *Flow*) to the Moon to establish the structure of the lunar interior. *GRAIL*'s twin spacecraft uncovered massive regions (mass concentrations, or mascons) that make the Moon's gravity uneven, a phenomenon that affects the operations of lunar-orbiting spacecraft. In December 2012, the *GRAIL* spacecraft were intentionally crashed into a mountain near the Moon's North Pole. Each impact kicked up a cloud of dust and gas, allowing the *LRO* to record and examine the debris and provide researchers with more information about the Moon's composition.

The *Lunar Atmosphere and Dust Environment Explorer (LADEE)* is NASA's latest venture to the Moon. The goals of this new mission are to determine the composition and



Figure 1 — LADEE with Lunar Laser Communication Demonstration (LLCD).
Image Credit: NASA/LADEE

structure of the lunar atmosphere and to understand how the atmosphere changes with time.

Now, the name of this instrument may be a curious one to some. Lunar atmosphere?

For as long as I can remember, it has generally been accepted that the Moon has no atmosphere. But recent observations suggest that our Moon has an extremely light atmosphere that includes sodium and potassium gas. This isn't the first time it was suggested that the Moon has an atmosphere. During the *Apollo 17* mission, atoms and molecules of helium, argon, ammonia, methane, and carbon dioxide were detected by the *Lunar Atmospheric Composition Experiment (LACE)*. Still, even with all these gases, the density of the lunar atmosphere is comparable to the outermost fringes of Earth's, at about the altitude of the *International Space Station*.

What produces these gases in the Moon's atmosphere? Scientists have suggested some possible causes: high-energy photons and solar-wind particles interacting with lunar surface material, or perhaps gases released as a result from the impacts of comets and meteoroids.

An extremely thin atmosphere such as that on the Moon is often called a "surface-boundary exosphere." A surface-boundary exosphere may be the most common type of atmosphere in the Solar System: it is found on Mercury, some large asteroids, and some of the moons of the Jovian planets. The surface-boundary exosphere on the Moon provides us with an opportunity to extend our understanding of many other objects in our Solar System.

LADEE will orbit the Moon for 100 days, carrying three science instruments: a neutral mass spectrometer (NMS) to measure the concentration of different atmospheric species; the ultraviolet/visible spectrometer (UVS) to measure the atmosphere and dust; and the Lunar Dust Experiment (LDEX) to measure dust particles.

LADEE also incorporates a new communications technology, the Lunar Laser Communication Demonstration (LLCD). The LLCD will send and receive data using infrared lasers rather than radio signals (Figure 1). The laser system uses a 30-cm telescope to direct a 622 Megabytes per second (Mb/s) communications stream from lunar orbit to Earth. This is considerably faster than current radio data rates of 100 Mb/s. Data will be sent to one of three ground telescopes—a primary one in New Mexico and secondary telescopes in California and Spain.

After the discovery of geologic activity by the *LRO*, ice deposits at the Moon's South Pole by *LCROSS*, and mascons by *GRAIL*, the discovery of a lunar atmosphere certainly makes one rethink what we learned in school about the Moon being "dead." *

Dave Garner teaches astronomy at Conestoga College in Kitchener, Ontario, and is a Past President of the K-W Centre of the RASC. He enjoys observing both deep-sky and Solar System objects and especially trying to understand their inner workings.

Second Light

Enceladus's Tidally Driven "Tiger Stripes"



by Leslie J. Sage
(l.sage@us.nature.com)

One of the most surprising discoveries made by the Cassini spacecraft as it travelled through the Saturnian system was in 2005, when it was found that the small, icy moon Enceladus was venting material into space. Subsequent passes by Cassini revealed four tears in the surface, near the south pole. These were dubbed "tiger stripes," though to me they look more the kind of cuts made by a big cat with its claws (Figure 1). Over the next few years, the plumes were found to be salty water, with some organic (carbon-based, but nothing to do with life) material mixed in. The tiger stripes had elevated temperatures, so there was fairly rapid agreement that tidal stresses arising from Enceladus's eccentric orbit were heating subsurface material—either water or ice—that was boiling off into space. A model of how the stresses acted on the crust predicted that the stripes would be most open when Enceladus was farthest from Saturn, and most closed when Enceladus was closest (see Hurford et al. 2007 *Nature* 447, 292; <http://adsabs.harvard.edu/abs/2007Natur.447..292H>). After another six years of gathering data, Matthew Hedman of Cornell University and his colleagues have demonstrated that the plumes are brightest when Enceladus is farthest from Saturn (see the August 8 issue of *Nature*, first published online on July 31), in line with the model prediction.

Enceladus is a small (500-km diameter) icy moon, orbiting Saturn within its E Ring. Voyager discovered that much of the

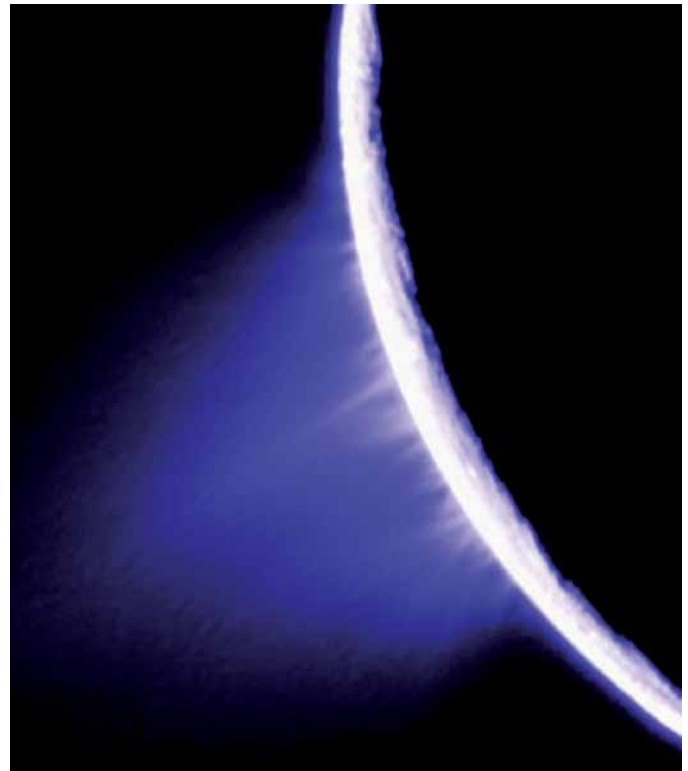

Figure 2 — A false colour image of the plume. (Image courtesy NASA and the creative commons on Wikipedia.)

surface is lightly cratered, indicating that it is "young," with the implication that something had caused resurfacing. In general, the more cratered a body is, the older it is—for example, the lunar maria are younger than the heavily cratered regions. The volcanic activity that resurfaced lunar craters occurred later than the episodes that caused most of the craters. The young parts of Enceladus were puzzling, because such a small body should not be able to undergo volcanism, though its location at the centre of the E Ring led to some suggestions that it was venting material that formed the ring.

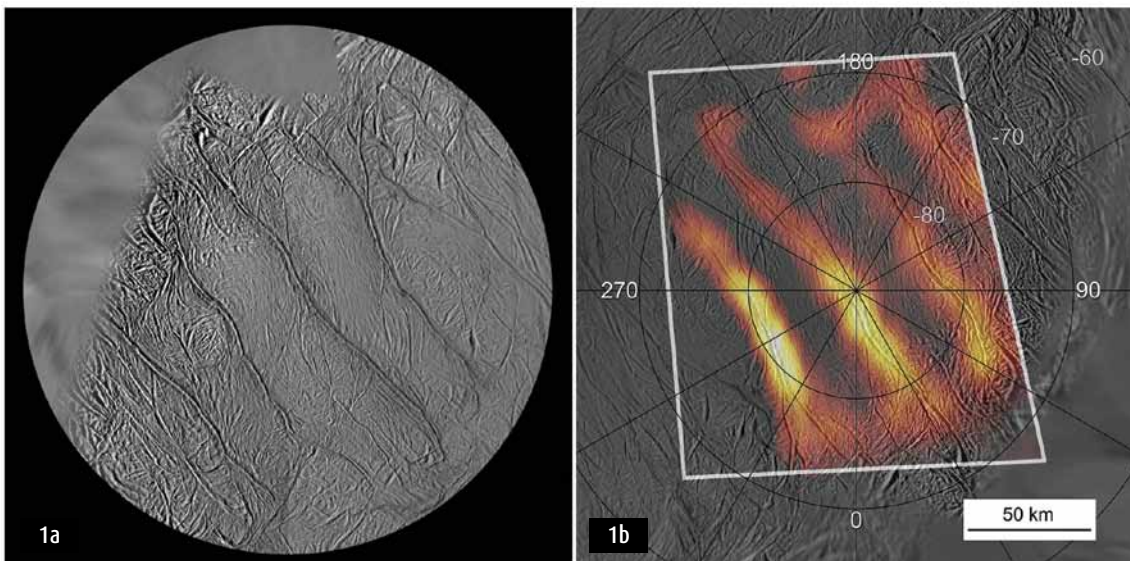

Figure 1a — A composite map of the southern polar region, showing the distinctive "tiger stripes." Figure 1b — A thermal image of the "tiger stripes," showing that they are hotter (red) than the surrounding terrain. (Images courtesy NASA and the creative commons on Wikipedia.)

Enter *Cassini* and the plumes. Demonstrating that the plumes were salty water led to the idea that Enceladus was resurfaced by water falling back onto its surface. (To be fair, a version of this had initially been suggested back in the 1980s.) The first suggestion was that Enceladus had a global subsurface ocean. That has subsequently been modified to subsurface water mostly near the south polar region, which fits better with the observation that the northern polar regions are the most heavily cratered.

Hedman and his colleagues used 252 images of Enceladus's plume in the near infrared (~900 nm to ~1500 nm) to track how the total brightness changed with position. *Cassini* and Enceladus are in separate orbits around Saturn, with *Cassini*'s being very eccentric, so the images are taken from very different distances and lighting angles. That means they all had to be corrected to a common distance to be able to extract the relationship between total brightness and the orbital phase (or, equivalently, Enceladus's distance from Saturn). This was the most complicated part of the project. Once that was sorted out, it became clear that the plume was brightest when Enceladus was farthest away from Saturn, just as predicted by Hurford's model.

Hedman and his colleagues found some other interesting points in their data. The plume was about 50 percent brighter in 2005 than it was during the 2009-2012 period, which may indicate a decrease in plume activity between 2005 and 2009, though this is very uncertain for now. They also found that ice particles were launched with higher velocities when Enceladus was close to Saturn, which might arise from changes in the crack geometry.

One of the very odd things about Enceladus is that it is geologically active, while Mimas, which is about the same size, closer to Saturn, and in a more eccentric orbit, is dead. One possible explanation is that, with relatively more rock than Mimas, Enceladus was partially differentiated when it was young, with the heavier and radioactive elements sinking towards the centre, leaving behind magma chambers that could be "pumped" by the changing tidal stresses.

The next time you are observing Saturn, give a thought to the E Ring, and how it got there. It was shot out of Enceladus, a bit at a time. *

Leslie J. Sage is Senior Editor, Physical Sciences, for Nature Magazine and a Research Associate in the Astronomy Department at the University of Maryland. He grew up in Burlington, Ontario, where even the bright lights of Toronto did not dim his enthusiasm for astronomy. Currently he studies molecular gas and star formation in galaxies, particularly interacting ones, but is not above looking at a humble planetary object.

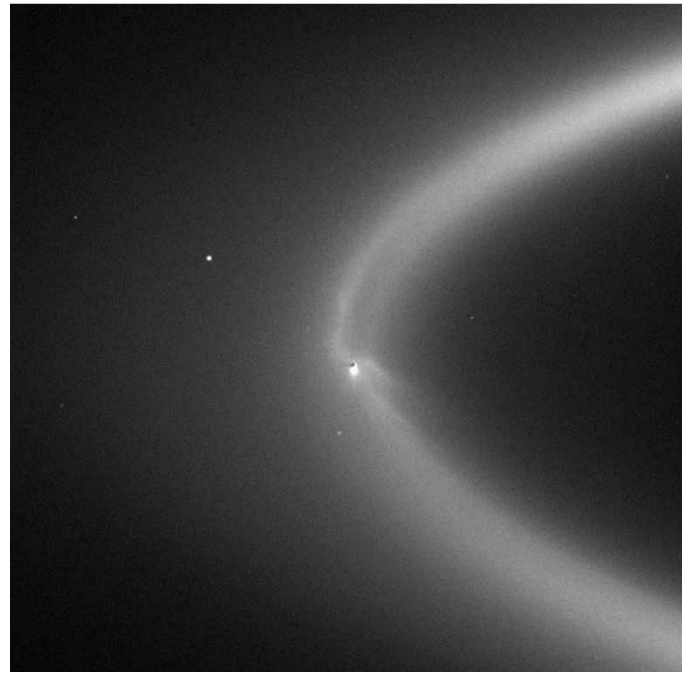

Figure 3 — Enceladus embedded in the E ring, showing wispy ice crystal plumes spewing from the moon's south pole into Saturn's E ring. (Image courtesy NASA and the creative commons on Wikipedia).

SERVING AMATEUR ASTRONOMERS FOR OVER 22 YEARS!

toll-free 1-800-580-7160
info@khanscope.com

www.khanscope.com

All Major Brands of Telescopes including:
 Meade | Celestron | TeleVue | Coronado | APM
 SkyWatcher | William Optics | Rigel | Baader
 Nikon | Antares | Telrad | Denkmeier | Equinox
 Thousand Oaks | Kendrick | Lunt Solarsystems
 TeleGizmos | Ioptron | Sky Pub & Others

NEW | USED | TRADE-INS
WE SHIP CANADA WIDE

KHAN SCOPE CENTRE

3243 Dufferin Street, Toronto, ON M6A 2T2
 Phone: 416 783 4140 | Fax: 416 352 1701

Reviews / Critiques

The Cambridge Photographic Moon Atlas, by Alan Chu, Wolfgang Paech, and Mario Weigand (English translation by Storm Dunlop), pages 91 + iv, 35 cm × 25 cm, Cambridge University Press, 2010. Price \$59.95, hardcover (ISBN: 978-1-107-10973-7).

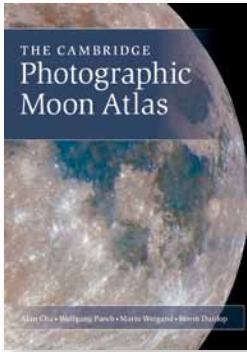

Amateur astronomers seem to have a special passion for atlases of all types, and the lunar variety is no exception. When I was asked to review the new *Cambridge Photographic Moon Atlas* by Alan Chu, Wolfgang Paech, and Mario Weigand, I was slightly skeptical that the amateur community truly needed yet another lunar atlas, but my initial impressions of the atlas were quite favourable. It is a large format (35 cm × 25 cm),

hardbound, glossy, coffee-table-type publication, and a product of very high-quality printing standards.

The lead author, Alan Chu, is a well-known lunar imager based in Hong Kong, whose *Photographic Moon Book* (<http://www.alanchuhk.com/>) has been praised on www.cloudy-nights.com, among other places (*The Cambridge Photographic Moon Atlas* is not unlike Chu's *Photographic Moon Book*). The names of his principal co-authors should be familiar to those who frequent the LPOD (Lunar Photo Of the Day) Web site (<http://lpod.wikispaces.com/>). Wolfgang Paech and Mario Weigand have had many of their fine high-resolution images featured and interpreted by the selenologist Charles Wood of Wheeling-Jesuit University (VA), *Sky & Telescope's* resident lunar geologist and the creator of LPOD. Additional images are contributed by Wolfgang Sorgenfrey, and Michael Theusner, the last of whom is the author of a fine lunar photo-stacking program known as AviStack (www.avistack.de). This is an impressive amateur group, and needless to say, the images included in the atlas are among the best in the world using 11-inch to 14-inch instruments.

Most astronomers who have had an interest in owning a lunar reference probably have one or both of the following in their library: Antonin Rühl's celebrated and very practical *Atlas of the Moon* (first edition 1976; latest edition 2004), and the *Virtual Moon Atlas* (VMA) created by Christian Legrand and Patrick Chevalley (www.ap-i.net/avl/en/start). Rühl's atlas, which features clear and detailed air-brush drawings and a rapid reference key, is unfortunately out-of-print, and consequently very scarce on the market and when found, commands a high price. The VMA is a very flexible and powerful program, and best of all, it is available as freeware. I use the VMA almost exclusively to plan my imaging runs on the Moon because it can give me a precise view of the

lunar terminator on any given night. So the question is, how does the new Cambridge atlas augment existing works for the aspiring observer, astroimager, or sketcher? An answer can be found in the rational layout of the new atlas, and in its practical and informative nature.

The inside cover and first page of *The Cambridge Photographic Moon Atlas* offer a photographic key for the first 40 pages. There are full-disk photos of the crescent, near-first quarter, and first quarter Moon with labelled numbers directing the user to the corresponding plate number. The last two pages of the book have images of the waxing-gibbous to near-full Moon with labelled numbers referring to the last 25 plates. The layout is not as easy to use as the grid key in Rühl's atlas, but it is certainly easy enough to find whatever in-depth image is needed for an observing session. Following a brief preface and description of how to use the atlas are 21 pages on the origin and evolution of the Moon and a very well laid-out guide to the types of structures one finds on the Moon, including the different types of craters. This section of the book is well supplemented with *Apollo* imagery and good diagrams and photos of Earth-bound analogues of similar structures, such as collapsed lava tubes.

The following section of the atlas came as a pleasant surprise. Brief mention is made of observational techniques with telescopes of varying sizes, but the authors also go into some detail on the techniques for imaging and processing. I thought this was very *à propos* given that the atlas consists of high-resolution images captured by amateurs. The reader is introduced to "lucky" imaging techniques, in which many hundreds of individual images are caught using fast shutter speeds and are then combined to give a much higher-resolution final image. "Lucky" imaging is precisely the technique that allows modern amateur imagers with modest equipment to capture images that easily surpass the emulsion photographs taken with the world's largest telescopes decades ago! The authors' thoughtfulness provides a great head-start for any reader inspired by the very excellent photos to try lunar imaging with the equipment he or she may have at hand.

The meat of the atlas consists of its 69 photographic plates, which are well laid-out and easy to read and interpret. The most interesting features of each image are labelled and described, and frequently multiple images of the same formation are displayed to give an idea of how the solar angle can drastically alter a feature's appearance. For example, plate 19A features Rupes and Rima Cauchy in Mare Tranquillitatis. Those features can only be spotted easily when they are relatively near the terminator, but the two photos also show that a very low solar angle is needed to observe all the myriad lunar domes (extinct volcanic structures) south of Rupes Cauchy. *The Cambridge Photographic Moon Atlas* is not meant to be an exhaustive photographic record of all lunar features, but it does give a very complete overview of 422 of the most interesting geological formations that one can observe and image (or draw) on the

Moon. The final pages provide a short description of the lunar far side, a glossary, an index of lunar features (giving latitude, longitude, and plate number), and finally a very good guide to further reading, including Internet sites and recommendations of software useful to the lunar observer.

Overall, I can certainly recommend *The Cambridge Photographic Moon Atlas* to anyone who would like to expand the planning of their lunar observing sessions. The atlas is handsome and well-designed, and would make a fine addition to any amateur's lunar library. The fact that the images contained within its pages are entirely of amateur origin can and should inspire budding lunar imagers to try the same. With a bit of practice and this book as a guide and inspiration—and good luck in the seeing department—anyone may with time feel confident enough to submit their own images to a site like LPOD. ★

Michael Wirths

Michael Wirths has been a member of the Ottawa Centre of the RASC for ~15 years, 10 of which were spent just outside Perth, Ontario, and the last five years with his wife Pamela building and running an off-grid astro B&B in the mountains of northern Baja California, Mexico. His primary astronomy activities include high-resolution lunar/planetary work and deep-sky observing with his two Starmaster Dobsonians.

Introduction to Planetary Geomorphology, by Ronald Greeley, pages 252 + xiv, 28 cm × 22 cm, Cambridge University Press, Cambridge, 2013. Price US\$85.00, hardcover (ISBN: 978-0521867115).

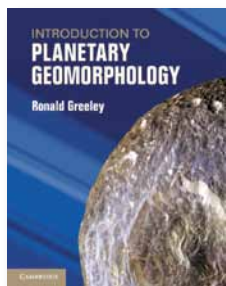

Introduction to Planetary Geomorphology is an excellent compendium of planetary geomorphology incorporating data up to 2011. For those who do not know, geomorphology is the scientific study of landforms and the processes that shape them. The book is best described as an advanced Planetary Geomorphology 101 reference, complemented with a strong index,

and well-defined geomorphologic terms. Given my amateur interest in geology and impact structures, Greeley does not disappoint.

Ronald Greeley (1939–2011), a pioneer in the field of planetary geology, served as the director of the NASA-ASU (Arizona State University) Regional Planetary Image Facility, and was principal investigator of the Planetary Aeolian Laboratory at NASA-Ames Research Center. He served on and chaired many NASA and National Academy of Science panels, and he was involved in nearly every major space-probe mission flown in the Solar System, including the first *Apollo* Moon landing. *Planetary Geomorphology* contains the data he gleaned from those experiences. Unfortunately, Greeley passed

away suddenly in the fall of 2011, just a month after submitting the book for publication.

Greeley uses the geomorphology process to explain the geologic complexities of our Solar System. The geomorphic process incorporates the analysis of data from space probes presented as geological maps, geological time data, remote sensing, geophysical data, image processing and cartographic data, geological simulations of planetary environments, and the study of terrestrial analogs.

Greeley first provides a detailed description of the geomorphology of Earth. He does that to enable us to compare landform signatures on our planet with those on other Solar-System bodies. He then documents in separate chapters the geomorphology of our Moon, Mercury, Venus, Mars, the Jupiter System, the Saturn System, and the Uranus and Neptune Systems.

The chapter on each documented Solar System body begins with an introduction explaining the object's basic data and history of exploration. That is followed by a description of the body's interior characteristics, and data on surface composition. The morphologic process associated with each body—tectonism, volcanism, impact cratering, and gradation (through weathering, mass wasting and hydrologic erosion)—is documented in detail. Such data are then compiled to present the geologic history of the planetary body. Each chapter concludes with assignment questions. Even though the background knowledge required to answer the questions exceeds my level of amateur knowledge, I feel they provide an impetus to dig deeper into the subject matter. For example: “Describe the different Aeolian (wind) processes which move sand grains on Mars and Venus,” or “Explain how the lunar volcano and its formation process differs from the volcanoes on Venus.”

For me, the book was somewhat demanding in spots, which meant I had to refer to the index to locate relevant information before I could continue. The advantage is that I picked up many facts that I did not know, and found a few mysteries new to me. For example, knowing that the gravity on Mercury is about twice that of the Moon, I understand that lunar crater ejecta are blasted further from the source crater than is the case on Mercury. On Mercury, however, the rays from some of the craters are longer than their lunar counterparts, opposite to what one would expect.

It is unfortunate that Greeley's untimely passing prevented him from incorporating the more recent science yield from current missions. Specifically, additional data from the ongoing probes at Mercury (MESSENGER), at Mars (Curiosity), and at Vesta would be welcome additions. That minor and unavoidable quibble aside, *Planetary Geomorphology* gives us an excellent template for documenting data from future Solar System space probes.

Introduction to Planetary Geomorphology is a testament to the scientific curiosity of mankind to discover “what is out there.” It also acknowledges the contributions of the technicians, engineers, and scientists who are dedicated to space exploration by summarizing the gathered Solar System geomorphologic knowledge to date. Now, please excuse me while I compile a table for the chasmata on Titania, Oberon, and Ariel. *

Charles O’Dale

Charles O’Dale’s daytime expertise before retirement was in precise semiconductor failure analysis. Since then he has moved on to bigger things, namely impact cratering. He has created a much-cited Web-resource on North American impact craters, the fruit of thorough reviews of the scientific literature and his own expeditions to sites (<http://ottawa-rasc.ca/wiki/index.php?title=Odale-Articles>).

The Quest to Regain Paradise, by Richard Hewitt, pages 279 + x, 20 cm × 12.5 cm, York Publishing Services, York, 2013. Price \$7.77, paperback (ISBN: 978-0-9576060-0-5).

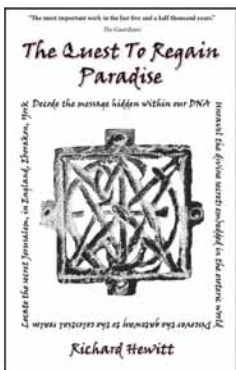

A book like *The Quest to Regain Paradise* would not normally be selected for review in JRASC, but the story associated with its creation by Richard Hewitt contains elements that may be of interest to astronomy enthusiasts. *Quest* is somewhat like a Dan Brown thriller, as different symbols enter the *Quest* story to be decoded and explained before the next step in the pursuit takes place.

But the pursuit in this instance is

primarily passive, without the life or death urgency of *The Da Vinci Code* or *Angels and Demons*. *The Quest to Regain Paradise* is essentially, as the title suggests, a search for the hidden information that mankind could have learned in the Garden of Eden from the tree of knowledge.

The story described in *Quest* is apparently based on true-life events and represents the author’s research over the past two decades into mankind’s quest to regain the lost knowledge of the ancients that in many cases is embodied in ancient architecture and symbols. However, the events described in Hewitt’s story appear to be mostly fictional, particularly the rather curious twist described in the final chapters, which I will not reveal here.

Richard Hewitt is a resident of York, England, in and around which the events of *Quest* are based. As noted at the beginning, York, ancient Eborakon, is the Jerusalem of the well-known British hymn, and plays an important role in mankind’s quest to regain paradise. York Minster, in particular, plays a pivotal role in the story, as do other iconic features within a few hours’ drive of the city.

The story begins with the author’s search for information about the symbolism associated with the white rabbit from Lewis Carroll’s *The Adventures of Alice in Wonderland*. Hewitt’s thoughts range from the realization that the phrase “follow the white rabbit” did not originate with Carroll to speculation on the ancient link between the white rabbit and the planet Venus, associated with rebirth, fertility, and sexuality. He muses that such connections may lie at the root of Hugh Hefner’s adoption of the white rabbit as a symbol for *Playboy* magazine.

As an aside, I can note that my mind began to wander at that point, and I immediately pictured a colleague at Saint Mary’s, Dr. Arthur Monaghan of the Philosophy Department, who owned a white Volkswagen Rabbit with a vanity license plate reading “IM LATE.” The symbolism was not lost on me, and acted as a spur for further reading.

Hewitt’s story returns much of the time to George Child, owner of The Old Vicarage Bookstore in Wakefield, who is constantly directing the author further and further into the iconography associated with *The Quest*, in a manner designed to provide just enough hints and clues for the author to discover the answers on his own. A first stop is St. Mary’s Church in Beverley, Yorkshire, which contains on the sculpted doorway to St. Michael’s Chapel a grinning white rabbit reputed to be the inspiration for Alice in Wonderland, certainly according to my guide book for Great Britain.

St. Mary’s Church is also of interest because its vestry ceiling contains a northern hemisphere star chart that appears to be set for an epoch near 1865, when the ceilings of the chancel and vestry underwent restoration work. I was queried about that by Hewitt because of a possible link to the work I did deciphering the star pattern on the chancel ceiling of St. John’s Church, Lunenburg, which contains a scene that replicates the Lunenburg sky as it would have appeared at the beginning of the first Christmas. The star scene at St. Mary’s Church differs in two respects from that at St. John’s: it is painted on a ceiling that is almost flat, unlike the gabled structure of the chancel at St. John’s, and does not represent a star scene that would exist naturally above Beverley—the star chart has the north celestial pole centred exactly overhead, for example. But there is one similarity; the star pattern at St. Mary’s contains added features, the planet Venus, a comet, and a conjunction of two planets, all of which have at one time or another been promoted as explanations for the Star of Bethlehem. Both appear to have some connection to the first Christmas.

Getting back to *Quest*, there are other items that may interest astronomy fanatics, once they get past the inundation of terminology—the Rosicrucian order, misericords, Grimoire, Anch, etc.—that had me frequently reaching for my dictionary. Of particular interest is the symbolism of snakes or dragons guarding the Tree of Life; a stylized version of the snake emblem is used on ambulances to denote the connection to the healing power of physicians. Snake symbols have a long history in astronomical lore, since all of the constellations

identified with snakes or dragons were used by the ancient constellation makers to denote important points in the sky. Draco, for example, wraps its coils around the north ecliptic pole and contains a star, Thuban, which was at one time the North Star. Serpens helps guard the autumnal equinox, and the faint stars of Hydra closely follow the celestial equator of about 4600 years ago. There is one important difference between the symbolism of the ancient constellations and that of *Quest*; I am unaware of any constellation associated with the Tree of Life.

Further associations with astronomy lore are contained in *Quest*, for example the similarity between the stars in the Belt of Orion and the layout of Egyptian pyramids, speculations about Stonehenge, etc. The historical aspects of astronomy have much in common with the historical ideas explored in *Quest*, so much of the story in *Quest* will therefore interest astronomy buffs. Overall *Quest* makes a good read and does maintain interest in the story. But I did find the conclusion a bit disappointing.

The writing and editing in *Quest* are both done well. My editorial eyes could not identify any typographical or grammatical errors, yet the small size and sometimes poor replications used for the figures are at times frustrating. Despite that, Hewitt has managed to squeeze a good tale and much of interest into a very reasonably priced book, which is also available for Kindle. If your tastes lie in this area, *The Quest to Regain Paradise* may engross you and educate you in enjoyable fashion. ★

David G. Turner

David Turner is the editor for book reviews in the Journal, and has an interest in the historical aspects of astronomy as well as the origin of the constellations and how they relate to the progressive development of mankind.

Our Enigmatic Universe: One Astronomer's Reflections on the Human Condition, by Alan H. Batten, pages 205+xiv, 15 cm × 21 cm, Melrose Books, Ely, 2011. Price ~\$14. softcover (ISBN: 978-1907732034).

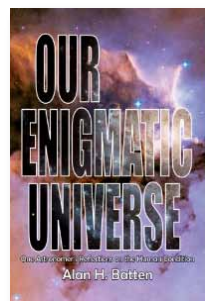

In later editions of his *Principia* (1713-), Isaac Newton stated that “to treat of God from phenomena is certainly a part of natural philosophy.” In the Rare Book Collection of the RASC Archives are two 18th-century editions of the Rev'd William Derham's (1657-1735) *Astro-Theology* (8th ed. 1741?, and 9th ed. 1750), a treatise wholly devoted to the “natural theological” enterprise, that is, finding evidence for the deity in the scientifically scrutinized natural world (Derham, a noted observational astronomer, was a friend and disciple of Newton). A mere century ago the majority of

RASC members—professional as well as amateur—would have shared a similar outlook to Newton's and Derham's on the Universe, one in which there were no contradictions between their religious beliefs and scientific practices. Times change, and that majority is now a small and circumspect minority within the RASC, as it is within the world of professional science. Some might welcome such a reversal as a healthy sign of the advance of scientific and rational attitudes throughout society in general, evidence that science is triumphing in the war with religion. Alan Batten's *Our Enigmatic Universe* provides good reasons to question such a facile reading of the present state of the relationship between religion and science, particularly within the scientific community itself.

Alan Batten should be well-known to members of our Society, having served as RASC National President 1976-1978 and editor of the *Journal* 1980-1988. His research specialty lies in the field of double- and multiple-star systems, and he spent his professional career as an astrophysicist at the DAO from 1959 to his retirement in the early 1990s. He is a founding member of CASCA and served as President from 1972-1974. He was Vice-President of the IAU from 1985-1991, and continues to be active on many IAU commissions dealing with multiple stars (radial velocities and spectroscopic binaries), as well as astronomical history and heritage, and EPO. He wrote a monograph on star systems (1973), has edited conference proceedings in the same area, translated Paul Couteau's visual double-star manual for MIT Press (1981), and somehow also found time to write a well-received study of the founders of the Struve astronomical dynasty (1988—the first decent monograph on a father-and-son team rivaling the Herschels in importance). And he has been associated with the Centre for Studies in Religion and Society of the University of Victoria since 1991.

According to Batten, three themes permeate his study: materialism is not the sole tenable philosophy for the scientifically informed, religious belief can be rationally defended, and the Universe remains enigmatic despite scientific progress (p. xiv, materialism is the doctrine that the Universe consists exclusively of that which is measurable and ultimately explicable solely through physical laws). He states that: “In recent decades, historians of science have amply demonstrated that the popular notion that science and religion are necessarily opposed to each other is false, while several theologians have tried to take account of modern scientific knowledge in their theology” (p. v). He suspects that the work of those historians of science and theologians is as unknown to working scientists as it is to working clergy, but while “at first sight, these two groups may appear to have little in common... many of their members share a common interest in the exploration of modern thought... I believe... that there is value in one person trying to integrate the results of these diverse lines of inquiry... I am, perhaps, feeling my way to a new kind of natural theology” (p. v).” The goal of his book, then, is to provide a means whereby the work, demonstrating

the artificiality of a “war” between science and religion, can come to the attention of those labouring in the labs and in the chancels. It also holds out the promise of a different, perhaps updated, natural theology. A secondary goal is to awaken readers to the over-simplistic dichotomy between “religion” and “science” carelessly contrived and polemically purveyed by the likes of Francis Crick, Richard Dawkins, Carl Sagan, and Steven Weinberg. In fact, Alan Batten himself is a sufficient demonstration against that dichotomy, as are Owen Gingerich, Guy Consolmagno, John D. Barrow, and Michał Heller, and as were A.S. Eddington, Allan Sandage, and Audoin Dollfus.

Chapters of varying length and complexity are devoted to “Humanity’s Expanding Perception of the Universe,” “How We Perceive the Universe,” “Belief in God,” “The Argument from Design,” “Life and Consciousness in the Universe,” “The Mind and the Brain,” “Reason and Revelation,” “Imagery, Miracles and Prayer,” “The Historical Relations of Science and Religion,” and “The Harmonization of Science and Religion.”

There are many things to like in Batten’s study. Excellent use is made of both the unfolding of our comprehension of electricity as a model for how major phenomena can remain opaque to scientific perception and understanding for so long, and the principles of Bayesian statistics to open a window on the role of bias in one’s own scientific practice (pp. 21-22; 29-30). The author is right to question those who seek a definitely final theory of everything, bringing with it the end of science and the death of wonder. Batten is too polite to say it, but the ahistorical hubris of that brand of scientific materialism is itself awesome (pp. 22-23). Likewise useful is the discussion of the limitations of Karl Popper’s definition of “scientific,” which leads to a call for all of us to be cognizant of the deficiencies within our views and methods (pp. 22-26; 173). The treatment of the thorny problem of the exclusivity claims of different religions is particularly enlightened (pp. 29-30) as is the explanation of what is meant by “revelation” (p. 118). Batten’s insistence on the dignity and ability of pre-modern scientists is particularly appealing to this reviewer (p. 64).

By now some may be wondering where the author stands on the question of Intelligent Design: “...the overwhelming majority of evolutionary biologists, including many who openly identify themselves as Christians, consider the

hypothesis of Intelligent Design to be both unnecessary and mistaken... As it is, Intelligent Design is hardly entitled to the status of a coherent alternative theory...” (pp. 66-67). One of the chief failings of Intelligent Design is that it all too often is a mere re-packaging of the hoary “God of the gaps”—here today, gone tomorrow (p. 73). Scientific rigour is not made of such things.

The treatment of extraterrestrials, religion, and science is commendable, particularly when it comes to the possible obstacles to communication (pp. 85-89). It cannot be stated often enough that any eventual discovery of extraterrestrial life, be it simple extremophiles or extraterrestrials, will pose no challenge whatsoever to the world views of mainstream western Christianity, or those of Eastern Orthodoxy (p. 80; it may prove otherwise, however, for those who have problems with Darwin, the age of the Universe, and quantum physics).

There are a few items one might wish were handled differently; space permits reference to only a few of them here. The term “orthodox Christianity” occurs many times, but is never defined. Its current usage is multivalent, and it would have been useful if the author had specified which he was employing. Speculations on the behaviour of early hominids seem not to be informed by the work of the last several decades (p. xi)—perusal of even a basic text such as Hardt, Henke, and Tattersall’s *Handbook of Paleoanthropology* (2007), or the offerings available on www.paleoanthro.org/home/ could have prevented that.

There are occasional occurrences of that which dare not speak its name, namely Whig history of science, but such lapses are easy to spot (p. xi). The account of the role of parallax (and similar issues) in the acceptance or rejection of Copernicanism could have greatly benefited from the recent work of Christopher Graney (available through arXiv).

To write of music as pre-existing in the “transcendent realm” (pp. 31-32) is hugely problematic, particularly for composers before the Romantic period’s invention of the artist as transcendent hero. Musicians such as J. S. Bach, W. A. Mozart, and Josef Hayden clearly worked in the prevailing craftsman mode of their day (as attested by Quantz’ *Versuch* 1752 and Tromlitz’ *Unterricht* 1791). Particularly unfortunate is the statement that Mozart conceived of the compositional process “...as one of discovery rather than creation,” quoted from

Is your address correct?

Are you moving?

If you are planning to move, or your address is incorrect on the label of your Journal, please contact the office immediately.

By changing your address in advance, you will continue to receive all issues of SkyNews and the Observer’s Handbook.

(416) 924-7973

www.rasc.ca/contact

Roger Penrose's *The Emperor's New Mind* (p. 32). Penrose cites Hadamard (1945), whose source text is the notorious Rochlitz forgery, *Allgemeine musikalische Zeitung* 17, 34 (1815), 561-566. Mozart, in the authentic statements regarding his compositional process, writes in terms of a craft process, a praxis much closer to the experimental process, that is, it is creation rather than "discovery" (e.g. letter to Leopold Mozart 1778 July 31).

The criticism of creeds as promissory notes granting admission to the spiritual speakeasy queue has some merit (pp. 48-49), but it must be remembered that creeds can function as adhesive texts for constructing communities, as plans for the conceptual architecture of belief, and as targets for probing and uncomfortable exegesis. If difference and variety in plenitude are seen as a good, and a sign of health in the ecumenical community, then credal differences are a boon rather than a liability. Perhaps creative unity ought to be sought above the level of credal differences, rather than in their erasure.

The best modern editions of works are not always used. The Cajori translation of the *Principia* (1934) is cited, which has been superseded by Cohen, Whitman, & Budenz (1999). Rosen's translation of Kepler's *Somnium* (1967) ought to have been used rather than the Kirkwood-Lear translation (1965). Darwin is best cited from the Barrett-Freeman edition (1986-1989) (unless one wants to cite darwin-online.uk, in effect the makings of a variorum edition).

The iconoclasm of many brands of present-day Judaism and Islam should not be projected too sweepingly into the past (p. 135). That is belied by books such as the *Sarajevo Haggadah* of AD 1350 with its abundant use of figural art, or al-Sūfi's *Kitab surwar al karwakib* (ca. AD 964) in the many medieval and early modern copies with illuminations of figural constellations. Many more examples could be cited.

Alan Batten has succeeded in writing a thoughtful study on a difficult topic. He does not hesitate to speak his mind, but he always does so with grace, goodwill, openness, and the optimism that there is a conversation to be had. The mission to disseminate work demonstrating the artificiality of a "war" between science and religion to the labs and the chancels is a noble one, even if the choice of a rather obscure publisher works against it. While *Our Enigmatic Universe* does not in the end offer an updated natural theology, it can serve as a worthwhile prolegomenon to such a project. ★

Randall A. Rosenfeld

Randall Rosenfeld is the Archivist of the RASC. He believes church music went into a decline after Orlando Gibbons. When not imposing his musical taste on college services, he can be found lurking at the back of the church extolling the virtues of extreme skepticism.

Society News



by James Edgar
(james@jamesedgar.ca)

As I write this, many RASC members are either preparing to view the August Perseid meteors, or they're busy processing the images already obtained over the past few days. Some, like me, even got some nice photos of the International Space Station passing over. With splendid weather, few bugs, dark skies, and plenty to see up there, what's not to like? I hope you had the chance to do some serious stargazing this summer.

Recent news: a nova has been discovered in Delphinus (The Dolphin), glowing at magnitude 5.7 by some accounts, and gaining in brightness rapidly. Go to http://media.skyandtelescope.com/documents/Nova_in_Delphinus_PSA64.pdf or www.aavso.org/vsp/ (under "Do you have a Chart ID" type in: 12508MG) for finder charts.

Your Board of Directors has been busy, too, preparing for a weekend retreat in Toronto in mid-September. We're nearly through the first long-range Strategic Plan that the previous Executive Committee formulated—it ran until the end of this

year. And, we have accomplished much of what we thought we would do. Not all, mind you, but most. So, it will be an interesting time to see what comes of the next Strategic Plan, this time with input from the permanent committees. We hope to include some of the committee goals when we reveal the next plan.

Speaking of the Board of Directors, in case you hadn't been paying close attention, the Board members are: Glenn Hawley, President; Colin Haig, 1st Vice-President; Chris Gainor, 2nd Vice-President; Denis Grey, Treasurer; James Edgar, National Secretary; Paul Gray, Director; Francois van Heerden, Director; and Paul Schumacher, Director. Without even trying, we have representation from one coast to the other on the Board!

Lastly, I had the great pleasure while visiting family to attend the Winnipeg Centre meeting on Friday, August 9. Probably the highlight there was Jay Anderson's photos and his talk about his Australian eclipse adventure from earlier in the year. The aurora and ISS pass, the pizza and beer afterward, and meeting up with new and old RASC friends all added to the pure enjoyment. Thanks to son-in-law, Mark Burnell, for getting me there on time and safely home again!

Clear skies! ★

Astrocryptic

by Curt Nason

ACROSS

1. Honoured astronomer you could easily part with (7)
5. Mystery award winner with a bad grade (5)
8. Spectral movement across the Jodrell dish, if tuned properly (5)
9. Crabby donkey sues all crooked stargazers (7)
10. Moore was dizzy to be the beau of a Uranian moon (5)
11. The racy rotation in the Greek home of Venus (7)
12. Award winner paid \$5 to play without starting (6)
14. Jupiter's recent home has weird rust-coated gold (6)
17. Award winner described Eros rotation before relatives returned (7)
19. Kemble's Cascade contains stars and those who study them here (5)
21. Final exam about some memory of elements like inclination and eccentricity (7)
22. I left Altair to observe in Ara (5)
23. It's heard from some who watch aurorae flash across the Ursa Minor sky (5)
24. Shakespeare ran back inside to characterize the immortal fire within (7)

DOWN

1. Iran's odd astronomer al-Tusi (5)
2. Our award-winning western assassin (7)
3. Short eyepiece made in North Ontario (5)
4. Dream of assembling a cabin in the sky around Uranus (6)
5. A heavenly sister saw the Spanish crater explode endlessly (7)
6. Legal problem concerning the discoverer of Neptune (5)
7. Scalars confuse us (7)
12. Iron also in supernova or seen in Jovian cloud belts (7)
13. Nagler can return to Alaska to star in The Belt (7)
15. Comet probe was a recycled toaster (7)
16. 1979 meteor seen from south Kentucky to Los Angeles and the tip of Baja (6)
18. He detected radio waves from north and south (5)
19. Berenice's feature on Cassiopeia's head rest (5)
20. Televised the start of alien intelligence research before briefing the editor (5)

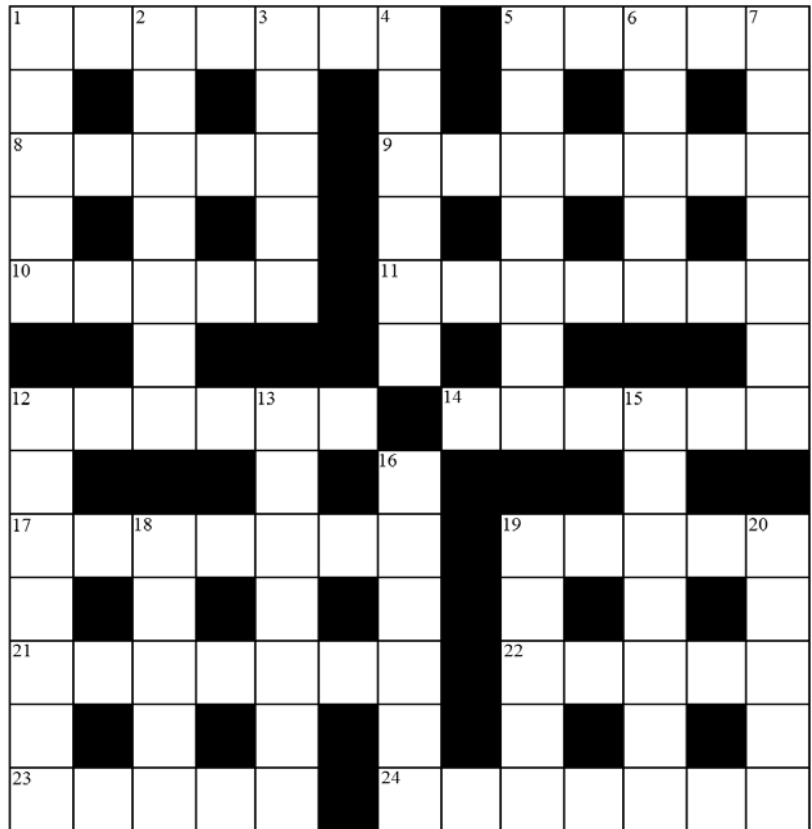

It's Not All Sirius

by Ted Dunphy

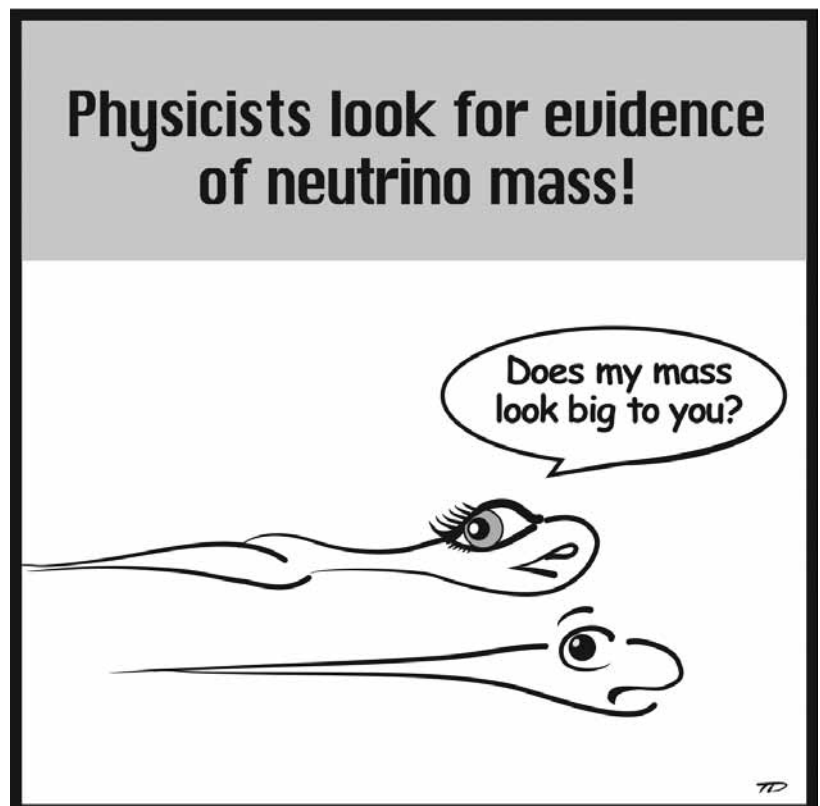

THE ROYAL ASTRONOMICAL SOCIETY OF CANADA

Board of Directors and appointed officers for 2013-2014 | Conseil d'administration et membres attirés pour 2013-2014

Honorary President	John Percy, Ph.D., Toronto
President	Glenn Hawley, B.Sc., B.Ed., Calgary
1st Vice-President	Colin Haig, B.Sc., M.Sc., Hamilton
2nd Vice-President	Chris Gainor, B.A., M.Sc., Ph.D., Victoria
Secretary/Recorder	James Edgar, Regina
Treasurer	Denis Grey, B. Math., M.B.A., Toronto
Director	Paul Gray, Halifax
Director	Francois van Heerden, Toronto
Director	Paul Schumacher, D.D.S., M.T.S., Victoria
Past President	Mary Lou Whitehorne, Halifax
Editor of Journal	Jay Anderson, B.Sc., MNRM, Winnipeg
Editor of Observer's Handbook	David M.F. Chapman, M.Sc., Halifax
Editor of The Beginner's Observing Guide	Brenda Shaw, Toronto
Editor of eBulletin	Dave Garner, B.Sc., M.o.A., Kitchener-Waterloo
Editor of Observer's Calendar	Paul Gray, Halifax
Executive Director	Deborah Thompson, CAE, Society Office

Centre addresses/Adresses des centres

The most current contact information and Web site addresses for all Centres are available at the Society's Web site: www.rasc.ca

Belleville Centre

c/o Greg Lisk, 11 Robert Dr
Trenton ON K8V 6P2

Calgary Centre

250, 300 5th Ave SW
PO Box 20282
Calgary AB T2P 4J3

Charlottetown Centre

c/o Brian Gorveatt,
316 N Queen Elizabeth Dr
Charlottetown PE C1A 3B5

Edmonton Centre

c/o TELUS World of Science
11211 142 St
Edmonton AB T5M 4A1

Halifax Centre

PO Box 31011, Halifax NS
B3K 5T9

Hamilton Centre

c/o Andy Blanchard, 2266
Lakeshore Rd W Oakville ON
L6L 1G8

Kingston Centre

PO Box 1793, Kingston ON
K7L 5J6

Kitchener-Waterloo Centre

305 - 20 St George St, Kitchener
ON N2G 2S7

London Centre

c/o Peter Jedicke,
82 Barrydale Cres
London ON N6G 2X4

Mississauga Centre

PO Box 98011,
2126 Burnhamthorpe Rd W
Mississauga ON L5L 5V4

Centre francophone de Montréal

C P 206, Station St-Michel
Montréal QC H2A 3L9

Montréal Centre

17 Kirkland Blvd, Unit 121
Kirkland QC H9J 1N2

New Brunswick Centre

c/o Emma MacPhee
26 Wilson Rd, Riverview
NB E1B 2V8

Niagara Centre

c/o Dr. Brian Pihack
4245 Portage Rd
Niagara Falls ON L2E 6A2

Okanagan Centre

PO Box 20119 TCM
Kelowna BC V1Y 9H2

Ottawa Centre

1363 Woodroffe Ave,
PO Box 33012
Ottawa ON K2C 3Y9

Prince George Centre

7365 Tedford Rd
Prince George BC V2N 6S2

Québec Centre

2000 Boul Montmorency
Québec QC G1J 5E7

Regina Centre

PO Box 20014
Regina SK S4P 4J7

St. John's Centre

c/o Randy Dodge,
206 Frecker Dr
St. John's NL A1E 5H9

Sarnia Centre

c/o Marty Cogswell,
6723 Pheasant Ln
Camlachie ON N0N 1E0

Saskatoon Centre

PO Box 317 RPO University
Saskatoon SK S7N 4J8

Sunshine Coast Centre

5711 Nickerson Rd
Sechelt BC V0N 3A7

Thunder Bay Centre

286 Trinity Cres
Thunder Bay ON P7C 5V6

Toronto Centre

c/o Ontario Science Centre
770 Don Mills Rd
Toronto ON M3C 1T3

Vancouver Centre

2302 West Fourth Ave
PO Box 19115
Vancouver BC V6K 4R8

Victoria Centre

3836 Pitcombe Pl
Victoria BC V8N 4B9

Windsor Centre

c/o Greg Mockler
1508 Greenwood Rd
Kingsville ON N9V 2V7

Winnipeg Centre

PO Box 2694
Winnipeg MB R3C 4B



Journal

Great Images

Jim Chung used a Sigma Foveon camera to record this June 24 image of the full Moon amid the altocumulus clouds over Toronto. Foveon cameras record red, green, and blue wavelengths at each pixel rather than in an array of single-colour pixels in most other digital cameras. In Jim's words, the camera has "exceptional colour fidelity and detail compared to comparably sized conventional sensor."